

MADE IN ITALY

# TeraPlast



2016

- Intro **Self Watering**
- Linea **Elements**
- Linea **Clear**
- Linea **Pastel**
- Linea **Colour**
- Linea **Basic**
- Display**
- Balconiere**
- T-basket**
- Linea **Flortec**
- Linea **Essential**
- Self Watering**
- Linea **Classic**
- Linea **City**
- Linea **Luce**
- Linea **Glossy**
- Linea **Brill**

made in Italy  collezione 2016

# TeraPlast

indice **PRODOTTI**  
Index  
Index  
Verzeichnis



- 8 Presentazione Teraplast
- 10 Legenda

### Intro **Self Watering**

- 12 Intro Self Watering

### Linea **Elements**

- 18 Hydral
- 26 Still
- 28 Aqua
- 30 Basilio

### Linea **Clear**

- 34 Porto/Plato
- 35 Madeira
- 36 Coimbra
- 37 Algarve

### Linea **Pastel**

- 40 Madeira pastel
- 42 Estoril pastel
- 44 Santiago pastel

### Linea **Colour**

- 48 Santiago
- 50 Estoril water reserve
- 52 Porto
- 56 Plato
- 58 Algarve
- 62 Madeira Luxy
- 64 Madeira
- 66 Coimbra

### Linea **Basic**

- 70 Cilindro new colour
- 72 Cilindro colour
- 73 Cilindro classic
- 74 Campana colour
- 75 Campana classic

- 76 Ciotola coste/Vaso coste
- 77 Ciotola con sottovaso
- 78 Sottovaso colour
- 79 Sottovaso classic
- 80 Quadro colour
- 81 Quadro classic
- 82 Cassettone colour
- 83 Cassettone classic
- 84 Sottovaso Quadro color/Sottovaso Quadro
- 85 Sottocassettone colour/Sottocassettone
- 86 Cassetta mare new colour
- 88 Cassetta mare colour
- 89 Cassetta mare classic
- 90 Cassetta Cortina colour
- 91 Cassetta Cortina classic
- 92 Cassetta Tirol
- 93 Cassetta Portofino colour
- 94 Cassetta Portofino classic
- 96 Cassetta coste
- 97 kit balcone Coste/supporto Coste/supporto Mare
- 98 Sottocassetta colour
- 99 Sottocassetta classic

### Display

- 100 Espositore cilindri e sottovasi
- 101 Espositore cassette e sottocassette
- 102 Espositore cilindri
- Espositore sottovasi

### Balconiere

- 104 display kit balcone Mare 1 pz
- 105 display kit balcone Mare 2 pz

### T-basket

- 108 T-Basket
- 110 T-Basket big

### Linea **Flortec**

- 114 vaso Norma
- 116 vaso Container/vaso Crisa
- 117 vaso Basso/Gabbia verde

### Linea **Essential**

- 120 Avila
- 122 Ribeira
- 124 Zamora
- 126 Standard One
- 128 Leon
- 130 Divio indoor/Corner indoor
- 133 Divio outdoor/Corner outdoor
- 134 Schio cassa alta
- 135 Schio cono
- 136 Schio cassa
- 137 Schio cubo alto
- 138 Schio cubo basso
- 139 Schio cubo
- 141 Schio ciotola
- 142 quadro Veneto
- 143 cassa Veneto
- 144 jardinera Veneto
- 145 tondo Veneto
- 146 Pasubio quadro
- 147 Pasubio cassa
- 149 Pasubio alto
- 150 Valentino
- 151 Bassano

### Self Watering

- 153 Divio self watering
- 154 Schio cubo self watering
- 155 Schio cassa self watering

### Linea **Classic**

- 158 Flora
- 159 cilindro Vicenza
- 160 cassetta liscia
- 161 quadro liscio
- 162 Africa/Tulipano
- 163 vaso festonato/vaso doppio bordo
- 164 campana Chiampo/cassetta Leonardo
- 165 cassetta millerighe/quadro millerighe
- 166 cassetta Molina/quadro Molina
- 167 ciotola Castello/conca Classica

- 168 vaso Muro righe/vaso Muro liscio/sottovaso Muro
- 169 sottovaso Tondo/sottovaso Quadro/Sottocassetta

### Linea **City**

- 172 New York
- 173 Venezia
- 174 Roma
- 175 A-Malo

### Linea **Luce**

- 178 Standard one outdoor
- 179 Spritz
- 180 Africa outdoor
- 181 Tulipano outdoor
- 182 Valentino outdoor
- 183 Pasubio alto outdoor
- 184 Bassano outdoor
- 185 Schio cassa alta outdoor
- 186 Schio cubo alto outdoor
- 187 Schio cono outdoor
- 188 A-malo luce outdoor

### Linea **Glossy**

- 192 tondo Veneto/Schio cono
- 193 Valentino

### Linea **Brill**

- 196 Tronco
- 197 Cono

### Accessori

- 198 Accesorio





## Passione per la sperimentazione

Teraplast è una nuova realtà nel panorama dei vasi in plastica e si distingue per flessibilità, innovazione e gamma di prodotti. Produciamo articoli con tecnologia ad iniezione e rotazionale riuscendo a soddisfare le esigenze di settori diversificati. Inoltre possiamo realizzare, a richiesta, tutti gli articoli in una ampia gamma di colori.

Siamo in grado di soddisfare le esigenze della clientela più esigente fornendo servizi personalizzati come la progettazione e la realizzazione degli stampi, la lavorazione di materiali diversi, l'assemblaggio finale di più particolari e la realizzazione di imballi su misura.

Con la sua propensione all'innovazione, Teraplast è rientrata alla sperimentazione e alla ricerca al di là dei limiti dei materiali, delle tecnologie e delle forme, per arrivare a creare prodotti innovativi, fonti di ispirazione e di piacere alla vista.

Grazie ai suoi prodotti Teraplast continua la tradizione di eccellenza che da sempre è associata al marchio Made in Italy, riuscendo a coniugare la funzionalità del vaso e la dimensione estetica.

L'ampliamento della gamma con l'introduzione di arredi per esterni è stata la diretta conseguenza della filosofia aziendale, ed ha portato alla creazione di sedute, tavoli e lampade, reinventati per dare ad ambienti esterni la stessa ricercatezza di quelli interni.

Che si tratti di un vaso, di un tavolo geometrico o di un oggetto di design i prodotti Teraplast catturano l'attenzione e sono concepiti per essere sia funzionali che affascinanti, attestando l'eccellente capacità di lavorazione nel campo delle plastiche e dello stampaggio rotazionale.



## Passion pour l'experimentation

Teraplast est une nouvelle réalité dans le domaine des vases en plastique et se distingue par sa flexibilité, son innovation et sa gamme de produits. Nous produisons les articles avec une technologie d'injection et de rotation réussissant à satisfaire les besoins de secteurs bien diversifiés. Nous sommes également en mesure de réaliser, sur demande, tous les articles dans une large gamme de couleurs.

En mettant l'accent sur l'innovation, Teraplast est orientée vers l'expérimentation et la recherche au-delà des limites des matériaux, des technologies et des formes, pour arriver à créer des produits innovants, sources d'inspiration et de plaisir pour les yeux.

Grâce à ses produits Teraplast continue la tradition d'excellence qui a toujours été associée à la marque Made in Italy, alliant la fonctionnalité du vase à la dimension esthétique.

L'élargissement de la gamme avec l'introduction de mobiliers d'extérieur a été la conséquence directe de la philosophie d'entreprise, et a conduit à la création de sièges, tables et lampes, réinventés, pour donner aux locaux extérieurs la même finesse qu'aux locaux intérieurs.

Qu'il s'agisse d'un vase, d'une table géométrique ou d'un objet design, les produits Teraplast captent l'attention et sont conçus pour être à la fois fonctionnels et fascinants, en témoignant l'excellente capacité d'élaboration dans le domaine du plastique et du rotomoulage.

## Passion for innovation

Teraplast is a new player in the plastic vase sector and stands out for its flexibility, innovation, range and particularly competitive prices. We produce articles with injection and rotational technology and we are able to satisfy the requirements of diversified sectors. In addition we can produce, on request, all the articles in a wide range of colours and sizes.

We are able to satisfy the needs of the most demanding customers providing customised services like the design and production of moulds, the process of various mediums, the final assembling of special components and provide suitable packaging.

With its inclination to innovation, Teraplast focuses on experimentation and the search beyond the limits of materials, of technologies and forms, to create innovative products that are sources of inspiration and pleasing to the eye. Thanks to its products, Teraplast goes on with the tradition of excellence that for a long time has been linked to the Made in Italy mark, succeeding in conjugating the functionality of the vase and the aesthetic dimension.

The product range expansion through the introduction of outdoor furniture has been the direct consequence of the business philosophy, and the outcome is the creation of sits, tables and lamps, redesigned to give the outdoor environment the same refinement of the interior one.

That be a vase, a geometric table or a design object, the Teraplast products capture the attention and are conceived to be both functional and fascinating, attesting the excellent ability of workmanship in the plastic field and the rotational moulding.



## Leidenschaft für das Experimentieren

Teraplast ist eine neue Realität in Bereich der Plastikvasen, die sich durch Flexibilität, Innovation und ihre Produktpalette absetzt.

Wir produzieren unsere Produkte durch Injektions- und Rotations-technologie und können somit die Bedürfnisse diversifizierter Bereiche zufrieden stellen. Darüber hinaus sind wir in der Lage, bei Anfrage, alle Artikel in einer weitreichenden Farbskala zu realisieren.

Mit seiner Neigung zur Innovation orientiert sich TeraPlast an das Experimentieren und an die Forschung jenseits der materialistischen, technischen und formbedingten Grenzen mit dem Ziel, innovative Produkte, Inspirationsquellen und genussvolle Anblicke zu kreieren.

Dank seiner Produkte verfolgt Teraplast weiterhin die Tradition von Exzellenz, die seit jeher mit dem Siegel Made in Italy assoziiert wird. Somit gelingt es, die Funktionalität der Vase mit der ästhetischen Dimension zu vereinen.

Der Ausbau der Produktpalette mit der Einführung der Einrichtungsgegenstände für den Außenbereich war die direkte Konsequenz der Unternehmensphilosophie. So entstanden Sitzgelegenheiten, Tische und Lampen, die neu ausgedacht wurden, um den Außenbereichen die gleiche Finesse wie den Innenbereichen zu verleiten.

Ob es sich um eine Vase, einem geometrischen Tisch oder einem Designobjekt handelt, die Produkte von TeraPlast ziehen die Aufmerksamkeit auf sich und sind so konzipiert, dass sie sowohl funktional als auch faszinierend sind. Dies ist das Zeugnis der ausgezeichneten Fähigkeit in dem Kunststoff- und Rotationsverfahrensbereich zu operieren.

# Legenda

## Legenda

## Légende

## Legende

I vasi con la superficie lucida sono allegri e colorati. Si adattano facilmente al contesto creando un ambiente fresco e vivace.

Pots with glossy surface are jolly and bright. They be easily fit to the context, making the background fresh and vivid.

Les vases avec la surface brillante sont gais et colorés. Ils s'adaptent au contexte aisément en créant un milieu frais et vif.

Pflanzgefäße mit glänzender Oberfläche sind heiter und farbig. Sie richten sich nach dem Kontext und machen die Atmosphäre frisch und lebhaft.

I vasi con la superficie opaca sono eleganti e raffinati. Si prestano ad arredare i tuoi spazi con gusto e armonia.

Pots with matt surface are elegant and refined. They are fit to furnish your space with taste and harmony.

Les vases avec la surface opaque sont élégants et raffinés. Ils se prêtent à meubler vos espaces avec goût et harmonie.

Pflanzgefäße mit matter Oberfläche sind elegant und verfeinert. Ideal um Ihren Raum durch Geschmack und Harmonie auszustatten.

### Superficie lucida

Glossy surface  
Surface brillante  
Glänzende Oberfläche

### Superficie opaca

Matt finished  
Surface opaque  
Matt-Oberfläche



 sottovaso / saucer  
soucoupes / untersetzer

 display pallet

 pallet

 rotelle / wheels  
roulettes / rollen

 sacchetto / bag  
sachets /beutel

 pallet di scatole  
pallet of carton boxes

 fix ground

 supporto Cassetta Coste  
Iron support for Cassetta Coste  
Support pour jardinière Coste  
Träger für die Cassetta Coste

 sfuso / loose pieces  
en vrac / lose Stk

 scatola / box  
carton / karton

 fix wall

 supporto Cassetta Mare  
Iron support for Cassetta Mare  
Support pour Cassetta Mare  
Träger für die Cassetta Mare



Self Watering

La riserva d'acqua permette di alimentare le vostre piante senza bisogno di irrigarle spesso.

Water system allows to feed plants without needing to irrigate it often.

La réserve d'eau permet d'alimenter vos plantes sans besoin de leur irriguer souvent.

Das Wasser-Reservoir ermöglicht es, die Pflanzen zu versorgen, ohne oft zu gießen.



Predisposto per ruote  
Prearranged for rollers  
Prévu pour roues  
Vorgesehen für Räder



Facilmente lavabile  
senza detersivi  
Easy to wash without  
detergents  
Très facile à entretenir  
Einfach ohne  
Reinigungsmittel  
waschbar



Ecologico: atossico  
e riciclabile

Ecological: non-toxic  
and recyclable

Ecologique: recyclable  
et not toxique

Umweltfreundlich: nicht  
toxisch und recyclingfähig

Siamo molto orgogliosi del nostro impianto fotovoltaico da 1,17 MW, posizionato sui tetti dei reparti produttivi e del magazzino, con il quale produciamo energia pulita per poter produrre i nostri vasi. Questa scelta, insieme all'utilizzo di materie prime riciclate di alta qualità e a politiche atte ad evitare sprechi in fase di imballaggio, rende Teraplast uno dei produttori di vasi più sostenibile.

We are very proud of our photovoltaic installation of 1,17 MW, placed on the roof of our production and warehouse, wherewith we produce clean energy to produce our pots. This choice, together with the use of high quality recycled raw material and strict policies to avoid wastes in the packaging process, emphasizes Teraplast as one of the most environmental friendly company.

Nous sommes très fiers de notre installation photovoltaïque de 1,17 MW, positionné sur les toits des rayons productifs et du magasin avec laquelle nous produisons énergie propre pour pouvoir produire nos vases. Avec le choix d'utiliser des matières premières recyclées de haute qualité en contribuant à la politique d'antigaspiages en phase d'emballage, Teraplast devient un des producteurs de vases les plus respectables.

Wir sind sehr stolz auf unsere Photovoltaikanlage mit 1,17 MW, auf dem Werk- und Lagerdach, womit wir saubere Energie erzeugen, um unsere Töpfe herzustellen. Diese Entscheidung, zusammen mit der Verwendung von recycelt hochwertigen Rohstoffe und ohne Verschwendungen in der Verpackungsphase, macht TeraPlast einer der am nachhaltigsten Hersteller von Pflanzgefäße.



Foro predisposto  
Can be drilled to  
drainage  
Trous de drainage  
prévus  
Loch Vorsatz

I vasi con il foro predisposto possono essere facilmente forabili per permettere il drenaggio dell'acqua. Una volta effettuata questa operazione si consiglia l'abbinamento con il sottovaso adeguato.

Pre drilled pots can be easily drilled to allow the drain of the water. Once done this operation we recommend to combine them with the suitable saucer.

Les vases qui ont le trou prépercé peuvent favoriser le drainage de l'eau. Une fois cette opération effectuée veuillez demander conseil au distributeur afin de trouvé le dessous de pot correspondant.

Pflanzgefäße mit vorgesehenem Loch sind einfach durchzulöchern für den Wasserdrainage. Nach dem Durchlöchern ist die Benutzung des anpassenden Untersetzers zu empfehlen.



Con lampadina  
Illuminated  
Lumineux  
Mit licht



Resistente agli urti  
Shock resistant  
Résistant aux chocs  
Stoß und Bruchfest



Impilabile  
Stackable  
Impilables  
Stapelbar

Per agevolare il trasporto e la vendita a scaffale molti dei nostri vasi sono impilabili.

A wide range of our pots are stackable in order to ensure easy transportation and friendly merchandising.

Pour faciliter le transport et la vente en étagères beaucoup de nos vases sont impilables.

Unsere Pflanzgefäße sind stapelbar, um den Transport und den Verkauf auf Regale zu erleichtern.

## Intro Self Watering



diffusione dell'acqua  
per osmosi  
water diffusion through  
osmosis's effect  
diffusion de l'eau par  
osmose  
Wasserdiffusion durch  
Osmose

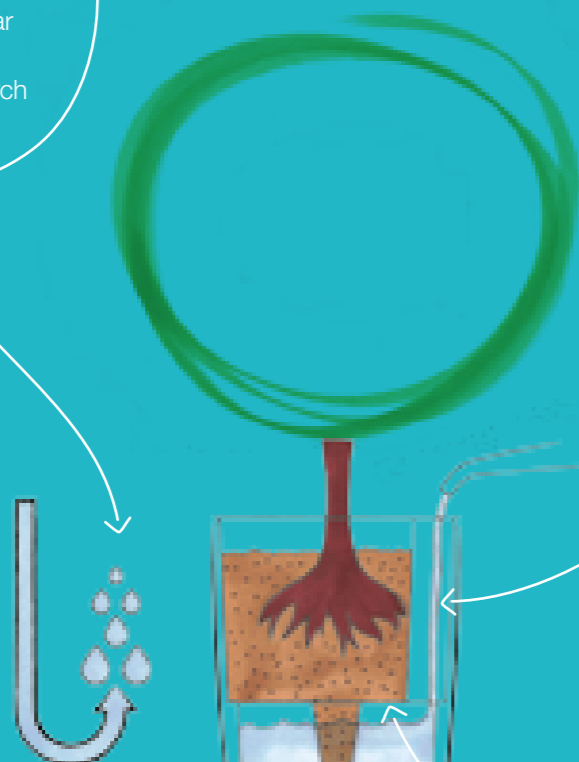

beccuccio per  
inserimento dell'acqua  
spout for water  
insertion  
bec pour l'introduction  
de l'eau  
Füllschacht zur  
Wasserversorgung

griglia di drenaggio  
drainage grid  
gril pour le drainage  
Bewässerungseinsatz

riserva d'acqua  
water reserve  
réserve d'eau  
Wasser-Reservoir

## Riserva d'acqua

La riserva d'acqua permette di alimentare le vostre piante senza bisogno di irrigarle spesso.

I fori di drenaggio per il "troppo pieno" permettono di scaricare eventuali eccessi di acqua così sarà la pianta stessa ad attingere alla riserva d'acqua quando ne avrà bisogno.

Alcuni dei vasi dotati di questo sistema presentano anche una membrana di rivestimento che, una volta rimossa, permette all'acqua in eccesso di fuoriuscire dal vaso.

## Water reserve

The water reservoir allows to feed your plants without having to water it often.

The drainage holes for the "overflow" allow you to download any excess water so the plant itself will be to draw on the reserve of water when it needs them.

Some of the pots equipped with this system also have a coating membrane that, once removed, it allows excess water to leak from the pots.

## Réserve d'eau

Le réservoir d'eau permet de nourrir vos plantes sans avoir à les arroser souvent. Les trous de drainage pour le «débordement» vous permettent de télécharger tout excès d'eau de sorte que sera elle-même à puiser dans la réserve d'eau quand il en aura besoin.

Certains des pots équipés de ce système ont également une membrane d'enrobage qui, une fois enlevé, permet à l'eau en excès de sortir

## Wasser-Reservoir

Das Wasser-Reservoir ermöglicht, Ihre Pflanzen zu versorgen, ohne ständig Wasser zuzuführen.

Die Entwässerungslöcher lassen das Wasser überlaufen, damit die Pflanze das nach Bedarf schöpfen kann.

Einige Pflanzgefäße mit Wasserspeicher besitzen eine Abdeckung-Membrane, die das Wasser, bei Wegnahme, überlaufen lässt.



## Intro Self Watering



**Hydral**  
pagina 18



**Still**  
pagina 26



**Aqua**  
pagina 28



**Estoril**  
pagina 50



**Algarve**  
pagina 58

Molti dei nostri vasi sono dotati di **riserva d'acqua**. Scopri i dettagli nelle pagine dedicate.

Most of our pots are provided with **water reserve** system. Find more details on the related pages.

Plusieurs de nos pots sont équipés de **réserve d'eau**. Découvrez les détails dans les pages dédiées.

Wir bieten viele Blumenkästen mit **Bewässerungssystem** an. Entdecken Sie die Details auf die entsprechenden Seiten.



**Cassetta Portofino**  
pagina 93



**Cassetta Coste**  
pagina 96



**Divio**  
pagina 153



**Schio Cassa**  
pagina 155

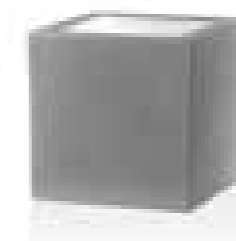

**Schio Cubo**  
pagina 154



INTRO SELF WATERING

linea  
**ELEMENTS**



hydra



still

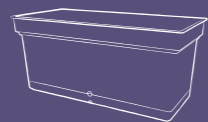

aqua



basilio





news  
2016

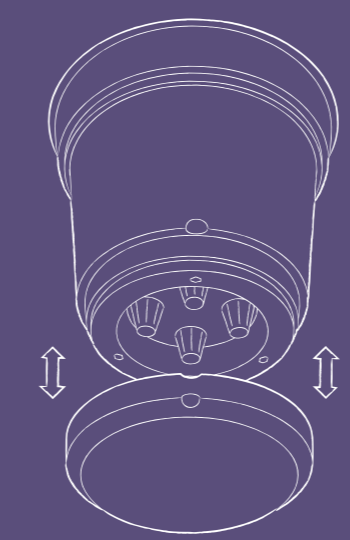

diffusione dell'acqua per osmosi  
water diffusion through osmosis's effect  
diffusion de l'eau par osmose  
Wasserdiffusion durch Osmose

riserva d'acqua  
water reserve  
réserve d'eau  
Wasser-Reservoir

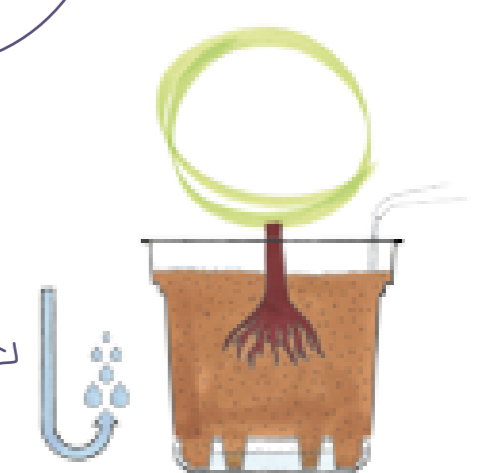

**414**  
fog grey/ fog grey  
brouillard gris/Nebel grau



**406**  
bruno/brown  
brun/braun

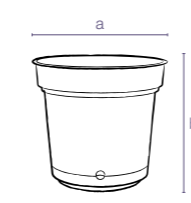

codice senza colore code without colour	Cm	dimensioni dimensions	litri liters	Confezione minima Minimum package	pezzi pallet pcs pallet	m <sup>3</sup>
28 107 18	18	a18 b16	2,5	5	1260	80x115x115h 1,06
28 107 23	23	a23 b21	5	5	840	80x115x115h 1,06
28 107 28	28	a28 b25	9,3	5	330	80x115x115h 1,06
28 107 33	33	a33 b30	15,3	5	200	100x115x115h 1,32
28 107 38	38	a38 b34	23	4	96	80x115x115h 1,06
28 107 48	48	a48 b43	46,5	4	144	100x115x230h 2,65
28 107 58	58	a58 b48	77	2	64	80x115x230h 2,65
28 107 68	68	a68 b55	120	1	26	78x78x230h 1,40
28 107 78	78	a78 b61	175,5	1	23	78x78x230h 1,40

Hydral



news  
2016



news  
2016



LINEA ELEMENTS

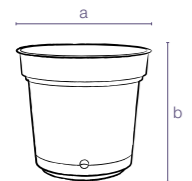

codice senza colore code without colour	Cm	dimensioni dimensions	litri liters	Confezione minima Minimum package	pezzi pallet pcs pallet	m <sup>2</sup>
28 107 18	18	a18 b16	2,5	5	1260 80x115x115h	1,06
28 107 23	23	a23 b21	5	5	840 80x115x115h	1,06
28 107 28	28	a28 b25	9,3	5	330 80x115x115h	1,06
28 107 33	33	a33 b30	15,3	5	200 100x115x115h	1,32
28 107 38	38	a38 b34	23	4	96 80x115x115h	1,06
28 107 48	48	a48 b43	46,5	4	144 100x115x230h	2,65
28 107 58	58	a58 b48	77	2	64 80x115x230h	2,65
28 107 68	68	a68 b55	120	1	26 78x78x230h	1,40
28 107 78	78	a78 b61	175,5	1	23 78x78x230h	1,40



**404**  
cedro/cedar  
cèdre/zeder



**022**  
bianco/white  
blanc/weiß





news 2016

news 2016

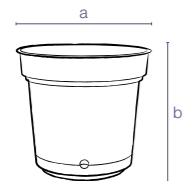

codice senza colore code without colour	Cm	dimensioni dimensions	litri liters	Confezione minima Minimum package	pezzi pallet pcs pallet	m <sup>2</sup>
28 107 18	18	a18 b16	2,5	5	1260	80x115x115h 1,06
28 107 23	23	a23 b21	5	5	840	80x115x115h 1,06
28 107 28	28	a28 b25	9,3	5	330	80x115x115h 1,06
28 107 33	33	a33 b30	15,3	5	200	100x115x115h 1,32
28 107 38	38	a38 b34	23	4	96	80x115x115h 1,06
28 107 48	48	a48 b43	46,5	4	144	100x115x230h 2,65
28 107 58	58	a58 b48	77	2	64	80x115x230h 2,65
28 107 68	68	a68 b55	120	1	26	78x78x230h 1,40
28 107 78	78	a78 b61	175,5	1	23	78x78x230h 1,40



**416**  
marsala/marsala  
marsala /marsala



**415**  
terra di Siena/terra di siena  
terra di siena/terra di siena



news  
2016

news  
2016

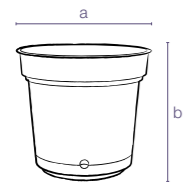

codice senza colore code without colour	Cm	dimensioni dimensions	litri liters	Confezione minima Minimum package	pezzi pallet pcs pallet	m <sup>3</sup>
28 107 18	18	a18 b16	2,5	5	1260	80x115x115h 1,06
28 107 23	23	a23 b21	5	5	840	80x115x115h 1,06
28 107 28	28	a28 b25	9,3	5	330	80x115x115h 1,06
28 107 33	33	a33 b30	15,3	5	200	100x115x115h 1,32
28 107 38	38	a38 b34	23	4	96	80x115x115h 1,06
28 107 48	48	a48 b43	46,5	4	144	100x115x230h 2,65
28 107 58	58	a58 b48	77	2	64	80x115x230h 2,65
28 107 68	68	a68 b55	120	1	26	78x78x230h 1,40
28 107 78	78	a78 b61	175,5	1	23	78x78x230h 1,40



**417**  
aluminium/aluminium  
aluminium/aluminium



**005**  
antracite/anthracite  
anthracite/anthrazitgrau



news  
2016

Still

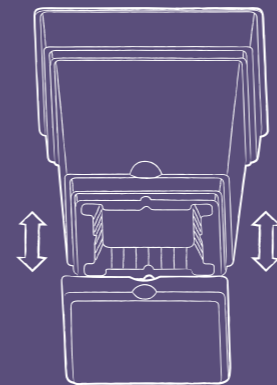

diffusione dell'acqua  
per osmosi  
water diffusion through  
osmosis's effect  
diffusion de l'eau par  
osmose  
Wasserdiffusion durch  
Osmose

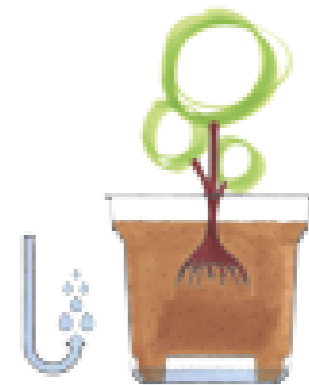

LINEA ELEMENTS



**022**  
bianco/white  
blanc/weiß



**417**  
aluminium/aluminium  
aluminium/aluminium



**414**  
fog grey/ fog grey  
brouillard gris/Nebel grau



**415**  
terra di Siena/terra di siena  
terra di siena/terra di siena



**406**  
bruno/brown  
brun/braun



**416**  
marsala/marsala  
marsala /marsala



**404**  
cedro/cedar  
cèdre/zeder



**005**  
antracite/anthracite  
anthracite/anthrazitgrau

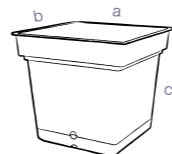

codice senza colore  
code without colour

28 111 038	022	417	414	415	406	416	404	005	38	a:38	b:38	c:38	29	1	246	80x115x230h	2,12
28 111 047	022	417	414	415	406	416	404	005	47	a:47	b:47	c:43	55	1	128	100x115x230h	2,65





news  
2016

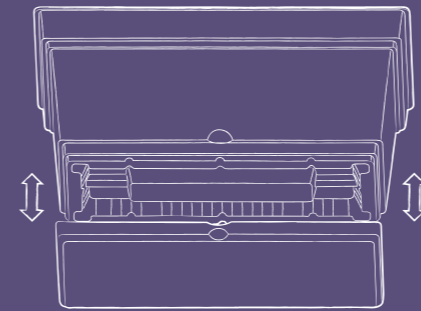

diffusione dell'acqua per osmosi  
water diffusion through osmosis's effect  
diffusion de l'eau par osmose  
Wasserdiffusion durch Osmose

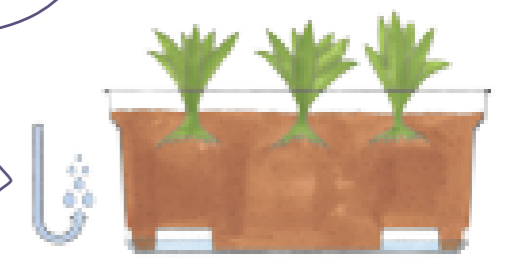

**022**  
bianco/white  
blanc/weiß



**417**  
aluminium/aluminium  
aluminium/aluminium



**414**  
fog grey/ fog grey  
brouillard gris/Nebel grau



**415**  
terra di Siena/terra di siena  
terra di siena/terra di siena



**406**  
bruno/brown  
brun/braun

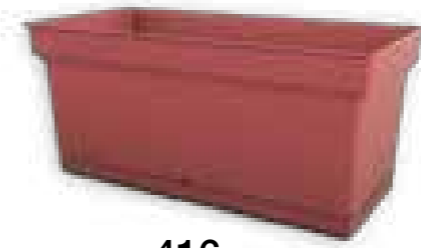

**416**  
marsala/marsala  
marsala /marsala

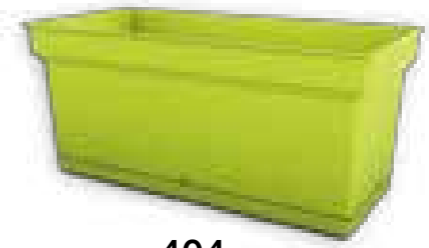

**404**  
cedro/cedar  
cèdre/zeder



**005**  
antracite/anthracite  
anthracite/anthrazitgrau

Aqua

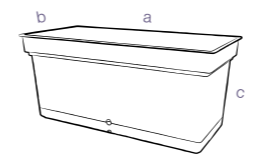

codice senza colore code without colour	Cm	dimensioni dimensions	litri liters	Confezione minima Minimum package	pezzi pallet pcs pallet	m <sup>3</sup>
28 109 078	022 417 414 415 406 416 404 005	78	a 78 b 38 c 38 66	1	123 80x115x230h	2,12
28 109 098	022 417 414 415 406 416 404 005	98	a 99 b 47 c 47 130	1	64 100x115x230h	2,65



news  
2016

# Basilio



Design by:  
favaretto/partners

**417**  
aluminium/aluminium  
aluminium/aluminium

adatto a: / suitable as: / adapté pour: / geeignet für:



**Still**  
pagina 26



**Aqua**  
pagina 28

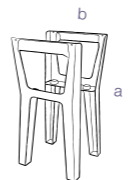

codice senza colore code without colour	Cm	dimensioni dimensions	Confezione minima Minimum package
28 113 078	61	a61 b32	262x33x25h



# linea CLEAR



porto



plato



madeira



coimbra



algarve





**Porto**  
pagina 52

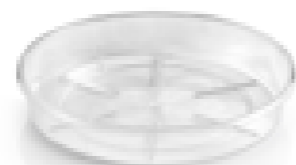

**Plato**  
pagina 56



**Madeira**  
pagina 62

LINEA CLEAR





**Coimbra**  
pagina 66



**Algarve**  
pagina 58



LINEA CLEAR

linea  
**PASTEL**



madeira



estoril



santiago





# Madeira pastel

Superficie lucida  
Glossy surface  
Surface brillante  
Glänzende Oberfläche

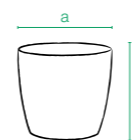

codice senza colore code without colour	Cm	dimensioni dimensions	litri liters	Confezione minima Minimum package	m <sup>3</sup>	pezzi pallet pcs pallet	m <sup>3</sup>
27 035 014	14	a14 b12,2	1	18 43x29x23h	0,02	972 80x120x225h	2,16
27 035 018	18	a18 b16,2	3	12 57x38x23h	0,05	432 80x120x225h	2,16
27 035 022	22	a22 b19,8	6	8 46x24x41h	0,04	240 80x120x220h	2,11



**412**  
acquamarina/aquamarine  
aigue-marine/aquamarin



**410**  
ghiaccio/ice  
glace/eis



**409**  
malva/mauve  
mauve/mauve



**411**  
porcellana/porcelain  
porcelaine/porzellan

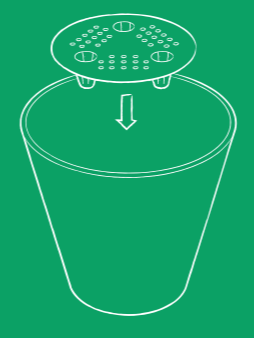

diffusione dell'acqua per osmosi  
water diffusion through osmosis's effect  
diffusion de l'eau par osmose  
Wasserdiffusion durch Osmose



riserva d'acqua  
water reserve  
réserve d'eau  
Wasser-Reservoir

foro di drenaggio per l'acqua in eccesso  
drainage bore for water's excess  
trou de drainage pour l'eau en excès  
Entwässerungsloch



**412**  
acquamarina/aquamarine  
aigue-marine/aquamarin



**410**  
ghiaccio/ice  
glace/eis



**409**  
malva/mauve  
mauve/mauve



**411**  
porcellana/porcelain  
porcelaine/porzellan

# Estoril water reserve pastel

Superficie lucida  
Glossy surface  
Surface brillante  
Glänzende Oberfläche

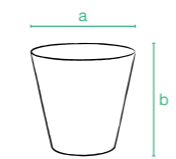

codice senza colore code without colour	Cm	dimensioni dimensions	litri liters	Confezione minima Minimum package	m <sup>3</sup>	pezzi pallet pcs pallet	m <sup>3</sup>
27 037 016	16	a16 b15	2	12 17x33x31h	0,01	1176 80x120x230h	2,2
27 037 020	20	a20 b19	3	8 21x21x40h	0,01	800 80x120x215h	2,1
27 037 025	25	a25 b23,5	6	6 26x26x44h	0,03	360 80x120x235h	2,2
27 037 030	30	a30 b28	12	4 31x31x39h	0,03	160 80x120x210h	2,0



ideale come porta vaso  
 ideal as cachepot  
 idéal comme pot de fleurs  
 ideal als Übertopf

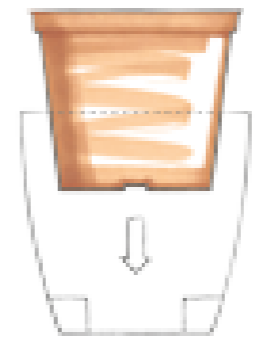

Linea Flortec  
 pagina 112



**412**  
 acquamarina/aquamarine  
 aigue-marine/aquamarin



**410**  
 ghiaccio/ice  
 glace/eis



**409**  
 malva/mauve  
 mauve/mauve



**411**  
 porcellana/porcelain  
 porcelaine/porzellan

# Santiago pastel

Superficie lucida  
 Glossy surface  
 Surface brillante  
 Glänzende Oberfläche

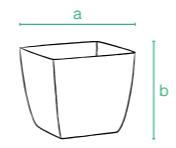

codice senza colore code without colour	Cm	dimensioni dimensions	litri liters	Confezione minima Minimum package	m <sup>3</sup>	pezzi pallet pcs pallet	m <sup>3</sup>
27 100 011	11	a11 b10	1	18 13x35x24h	0,01	2916 80x120x231h	2,22
27 100 013	13	a13 b12	1,5	18 15x28x36h	0,01	2160 80x120x231h	2,22
27 100 015	15	a15 b14,5	2,5	12 17x33x31h	0,01	1176 80x120x230h	2,21
27 100 020	20	a19 b17	5	8 21x21x40h	0,01	800 80x120x215h	2,06



# linea COLOUR

-  santiago
-  estoril
-  porto
-  plato
-  coimbra
-  algarve
-  madeira





# Santiago

Superficie lucida  
Glossy surface  
Surface brillante  
Glänzende Oberfläche



ideale come porta vaso  
ideal as cachepot  
idéal comme pot de fleurs  
ideal als Übertopf



Linea Flortec  
pagina 112



**022**

bianco/white  
blanc/weiß



**401**

peonia/peony  
pivoine/pfingstrose



**402**

lilyum/lilyum  
lilyum/lilyum



**028**

turchese/turquoise  
turquoise/türkis



**403**

corda/cord  
corde/seil



**404**

cedro/cedar  
cèdre/zeder



**407**

salvia/sage  
sauge/salbei



**406**

bruno/brown  
brun/braun



**006**

nero/black  
noir/schwarz

colour on demand 012 008 013 011 016 010 014 020 018 019 009 405 007 015 017 005

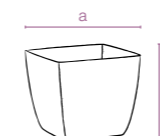

codice senza colore code without colour	Cm	dimensioni dimensions	litri liters	Confezione minima Minimum package	m <sup>3</sup>	pezzi pallet pcs pallet	m <sup>3</sup>
08 100 011	11	a11 b10	1	18 13x35x24h	0,01	2916 80x120x231h	2,22
08 100 013	13	a13 b12	1,5	18 15x28x36h	0,01	2160 80x120x231h	2,22
08 100 015	15	a15 b14,5	2,5	12 17x33x31h	0,01	1176 80x120x230h	2,21
08 100 020	20	a19 b17	5	8 21x21x40h	0,01	800 80x120x215h	2,06



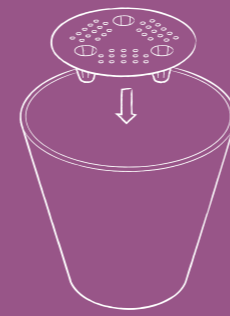

diffusione dell'acqua per osmosi  
water diffusion through osmosis's effect  
diffusion de l'eau par osmose  
Wasserdiffusion durch Osmose



riserva d'acqua  
water reserve  
réserve d'eau  
Wasser-Reservoir

foro di drenaggio per l'acqua in eccesso  
drainage bore for water's excess  
trou de drainage pour l'eau en excès  
Entwässerungsloch



**022**  
bianco/white  
blanc/weiß



**401**  
peonia/peony  
pivoine/pfingstrose



**402**  
lilyum/lilyum  
lilyum/lilyum



**028**  
turchese/turquoise  
turquoise/türkis



**403**  
corda/cord  
corde/seil



**404**  
cedro/cedar  
cèdre/zeder



**407**  
salvia/sage  
sauge/salbei



**406**  
bruno/brown  
brun/braun



**006**  
nero/black  
noir/schwarz



**Plato**  
pagina 56

colour on demand 012 008 013 011 018 010 014 020 018 019 009 405 007 015 017 005

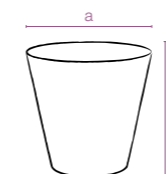

codice senza colore code without colour	Cm	dimensioni dimensions	litri liters	Confezione minima Minimum package	m <sup>3</sup>	pezzi pallet pcs pallet	m <sup>3</sup>
08 037 016	16	a16 b15	2	12 17x33x31h	0,01	1176 80x120x230h	2,2
08 037 020	20	a20 b19	3	8 21x21x40h	0,01	800 80x120x215h	2,1
08 037 025	25	a25 b23,5	6	6 26x26x44h	0,03	360 80x120x235h	2,2
08 037 030	30	a30 b28	12	4 31x31x39h	0,03	160 80x120x210h	2,0

# Estoril water reserve

Superficie lucida  
Glossy surface  
Surface brillante  
Glänzende Oberfläche

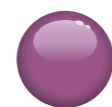



# Porto

Superficie lucida  
Glossy surface  
Surface brillante  
Glänzende Oberfläche

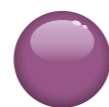

COLOUR



**024**  
trasparente/transparent  
transparent/transparent



**022**  
bianco/white  
blanc/weiß



**406**  
bruno/brown  
brun/braun



**010**  
rosso/red  
rouge/rot



**018**  
ciclamino/cyclamen  
cyclamen/zyklamfarbe



**019**  
lilla/lilac  
lilas/lila



**404**  
cedro/cedar  
cèdre/zeder



**407**  
salvia/sage  
saugé/salbei



**006**  
nero/black  
noir/schwarz



**Plato**  
pagina 56

colour on demand

codice senza colore code without colour	Cm	dimensioni dimensions	litri liters	Confezione minima Minimum package	m <sup>3</sup>	pezzi pallet pcs pallet	m <sup>3</sup>			
08 083 014	14	a 14 b 15	1	12	18	43x15x40h	0,02	380	80x60x115h	0,55
08 083 016	16	a 16 b 17,5	2	14	18	50x16x41h	0,03	270	80x60x115h	0,55
08 083 020	20	a 20 b 21,5	4	16	12	41x21x50h	0,05	154	80x60x115h	0,55
08 083 025	25	a 25 b 27	8	20	8	51x26x50h	0,06	66	80x60x115h	0,55
08 083 030	30	a 30 b 32,5	14	24	6	61x31x52h	0,09	84	80x120x200h	1,92
08 083 035	35	a 35 b 38	23	28	4	36x36x41h	0,05	72	80x120x223h	2,14
08 083 040	40	a 40 b 43,5	34	32	2	41x41x57h	0,09	42	80x120x227h	2,18

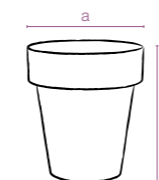



Porto



Plato



PORTO 14 + PLATO 12
PORTO 16 + PLATO 14
PORTO 20 + PLATO 16
PORTO 25 + PLATO 20
PORTO 30 + PLATO 24
PORTO 35 + PLATO 28
PORTO 40 + PLATO 32



## Porto ha il supporto per orchidea nelle misure 14 e 16

on the measures 14 and 16 Porto is featured with **orchids's** brackets

dans les mesures 14 et 16 Porto a un support pour les **orchidées**

Unterstützung für **Orchideen** in den Größen 14 - 16 vom Topf "Porto"

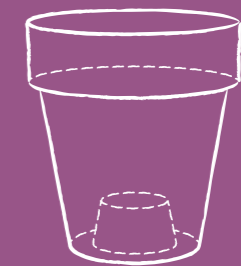

Porto



Porto



Ruote wheels



Plato  
pagina 56

COLOUR

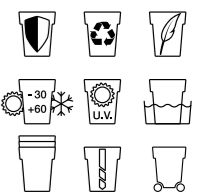

colour on demand 012 008 018 011 016 014 020 401 402 009 405 407 028 015 017 403 005



codice senza colore code without colour	Cm	dimensioni dimensions	litri liters	Confezione minima Minimum package	m <sup>3</sup>	pezzi pallet pcs pallet	m <sup>3</sup>			
08 084 014	022 406 010 018 019 404 407 006	35	a35 b38	23	4	36x36x41h	0,05	72	80x120x223h	2,14
08 084 040	022 406 010 018 019 404 407 006	40	a40 b43,5	34	2	41x41x57h	0,09	42	80x120x227h	2,18



# Plato

Superficie lucida  
Glossy surface  
Surface brillante  
Glänzende Oberfläche

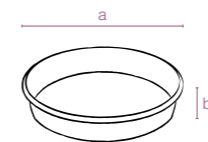
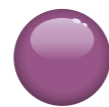

- 024**  
trasparente/transparent  
transparent/transparent
- 022**  
bianco/white  
blanc/weiß
- 403**  
corda/cord  
corde/seil
- 010**  
rosso/red  
rouge/rot
- 018**  
ciclamino/cyclamen  
cyclamen/zyklamfarbe
- 401**  
peonia/peony  
pivoine/pfingstrose
- 019**  
lilla/lilac  
lilas/lila
- 402**  
lilyum/lilyum  
lilyum/lilyum
- 028**  
turchese/turquoise  
turquoise/türkis
- 404**  
cedro/cedar  
cèdre/zeder
- 407**  
salvia/sage  
sauge/salbei
- 406**  
bruno/brown  
brun/braun
- 006**  
nero/black  
noir/schwarz

colour on demand 012 008 013 011 016 014 020 019 008 005 007 015 017 005

codice senza colore code without colour	Cm	dimensioni dimensions	Confezione minima Minimum package	m <sup>3</sup>	pezzi pallet pcs pallet	m <sup>2</sup>
08 086 012	12	a 12 b 2	18 12x12x12h	0,002	828	60x40x50h 0,12
08 086 014	14	a 14 b 2,3	18 14x14x12h	0,002	648	60x40x50h 0,12
08 086 016	16	a 16 b 2,7	12 16x16x12h	0,003	360	60x40x50h 0,12
08 086 020	20	a 20 b 3,3	8 20x20x12h	0,005	240	60x40x50h 0,12
08 086 024	24	a 24 b 4	6 24x24x12h	0,007	90	60x40x50h 0,12
08 086 028	28	a 28 b 4,7	4 28x28x12h	0,009	64	60x40x50h 0,12
08 086 032	32	a 32 b 5,2	2 32x32x8h	0,008	32	60x40x50h 0,12
08 086 036	36	a 36 b 5,2	2 36x36x8h	0,010	28	41x41x57h 0,09





# Algarve

Superficie lucida  
Glossy surface  
Surface brillante  
Glänzende Oberfläche

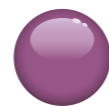

COLOUR



**024**  
trasparente/transparent  
transparent/transparent



**022**  
bianco/white  
blanc/weiß



**403**  
corda/cord  
corde/seil



**010**  
rosso/red  
rouge/rot



**018**  
ciclamo/cyclamen  
cyclamen/zyklamfarbe

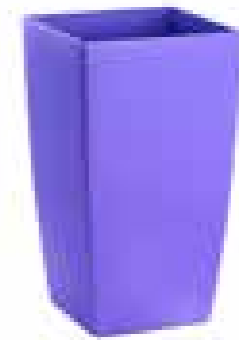

**019**  
lilla/lilac  
lilas/lila



**406**  
bruno/brown  
brun/braun



**404**  
cedro/cedar  
cèdre/zeder



**006**  
nero/black  
noir/schwarz

colour on demand 012 008 013 011 016 014 020 401 402 009 405 007 028 015 017 005

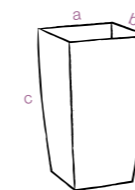

codice senza colore code without colour	Cm	dimensioni dimensions	litri liters	Confezione minima Minimum package	m <sup>3</sup>	pezzi pallet pcs pallet	m <sup>3</sup>
<b>08 018 026</b>	<b>26</b>	a15 b15 c26	4	12 46x31x36h	0,05	200	80x60x115h 0,55
<b>08 018 035</b>	<b>35</b>	a20 b20 c35	11	8 42x23x62h	0,06	88	80x60x115h 0,55
<b>08 018 042</b>	<b>42</b>	a25 b25 c42	20	4 51x26x51h	0,06	42	80x60x115h 0,55

1  
Algarve

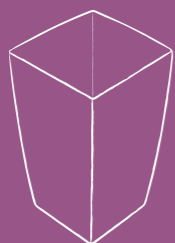

ideale per fiori recisi  
ideal for cut flowers  
idéal pour les fleurs coupées  
ideal für Schnittblumen

2  
Algarve  
+ self watering

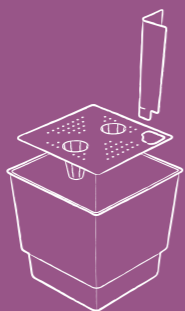
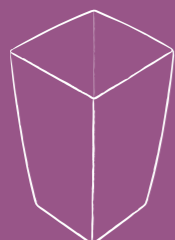

con riserva d'acqua  
with water reserve system  
avec réserve d'eau  
mit Wasser-Reservoir

2  
Algarve  
come portavaso

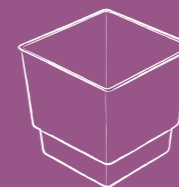
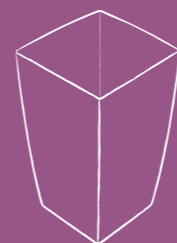

Linea Flortec  
pagina 112

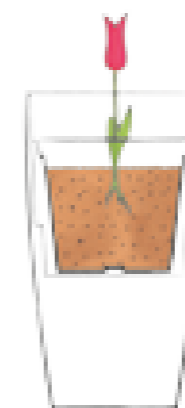

ideale come porta vaso  
ideal as cachepot  
idéal comme pot de fleurs  
ideal als Übertopf

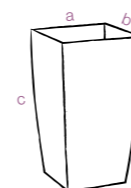

codice senza colore code without colour	Cm	dimensioni dimensions	litri liters	Confezione minima Minimum package	m <sup>3</sup>	pezzi pallet pcs pallet	m <sup>3</sup>
08 081 026	26	a15 b15 c26	4	12 31x31x61h	0,05	50 80x60x115h	0,55
08 081 035	35	a20 b20 c35	11	8 41x41x57h	0,09	44 80x60x115h	0,55
08 081 042	42	a25 b25 c42	20	4 51x26x68h	0,09	18 80x60x115h	0,55

### Kit Algarve Water Reserve

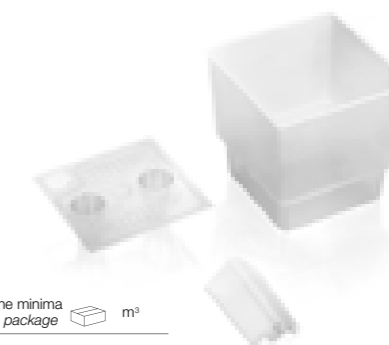

codice senza colore code without colour	Cm	dimensioni dimensions	Confezione minima Minimum package	m <sup>3</sup>
08 089 026	26	a14 b14 c14	12 15x15x47h	0,01
08 089 035	35	a18,5 b18,5 c20	8 20x20x45h	0,01
08 089 042	42	a23,5 b23,5 c23	4 25x25x37h	0,02



**024**  
trasparente/transparent  
transparent/transparent



**022**  
bianco/white  
blanc/weiß



**401**  
peonia/peony  
pivoine/pfingstrose



**402**  
lilyum/lilyum  
lilyum/lilyum



**404**  
cedro/cedar  
cèdre/zeder



**407**  
salvia/sage  
saug/salbei



**406**  
bruno/brown  
brun/braun



**006**  
nero/black  
noir/schwarz

colour on demand 012 008 013 011 016 010 014 020 018 019 009 405 007 028 015 017 403 005

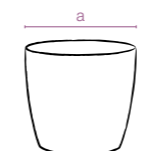

codice senza colore code without colour	Cm	dimensioni dimensions	litri liters	Confezione minima Minimum package	m <sup>3</sup>	pezzi pallet pcs pallet	m <sup>3</sup>
08 035 014	14	a14 b12,2	1	18 43x29x23h	0,02	972 80x120x225h	2,16
08 035 018	18	a18 b16,2	3	12 57x38x23h	0,05	432 80x120x225h	2,16
08 035 022	22	a22 b19,8	6	8 46x24x41h	0,04	240 80x120x225h	2,11

# Madeira Luxy

Superficie lucida  
Glossy surface  
Surface brillante  
Glänzende Oberfläche

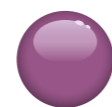





# Madeira

Superficie opaca  
Matt finished  
Surface opaque  
Matt-Oberfläche



**022**  
bianco/white  
blanc/weiß



**403**  
corda/cord  
corde/seil



**016**  
arancio/orange  
orange/orange



**010**  
rosso/red  
rouge/rot



**018**  
ciclamo/cyclamen  
cyclamen/zyklamfarbe



**019**  
lilla/lilac  
lilas/lila



**404**  
cedro/cedar  
cèdre/zeder



**406**  
bruno/brown  
brun/braun



**006**  
nero/black  
noir/schwarz

colour on demand

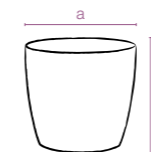

codice senza colore code without colour	Cm	dimensioni dimensions	litri liters	Confezione minima Minimum package	m <sup>3</sup>	pezzi pallet pcs pallet	m <sup>3</sup>
08 017 014	14	a14 b12,2	1	18 43x29x23h	0,02	400 80x60x115h	0,55
08 017 016	16	a16 b14,3	2	18 47x32x26h	0,03	304 80x60x115h	0,55
08 017 018	18	a18 b16,2	3	12 57x38x23h	0,05	216 80x60x115h	0,55
08 017 022	22	a22 b19,8	6	8 46x24x41h	0,04	104 80x60x115h	0,55
08 017 026	26	a26 b23,2	9	8 52x26x53h	0,07	48 80x60x115h	0,55



# Coimbra

Superficie lucida  
Glossy surface  
Surface brillante  
Glänzende Oberfläche

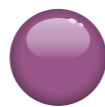

ideale come porta  
vaso  
ideal as cachepot  
idéal comme pot  
de fleurs  
ideal als Übertopf

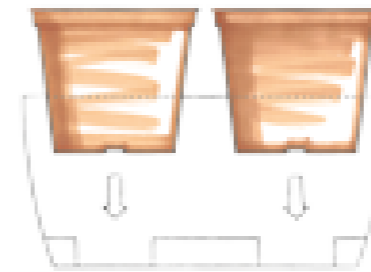

**Linea Flortec**  
pagina 112

**COIMBRA cm 30**  
Contiene 2 vasi da 14 cm  
Suitable to contain 2 pots cm 14  
Contient 2 pots de 14 cm  
Platz für zwei Vasen 14 cm

**COIMBRA cm 25**  
Contiene 2 vasi cm 12  
Suitable to contain 2 pots cm 12  
Contient 2 pots de 12 cm  
Platz für zwei Vasen 12 cm



**022**  
bianco/white  
blanc/weiß



**010**  
rosso/red  
rouge/rot



**018**  
ciclamino/cyclamen  
cyclamen/zyklamfarbe



**404**  
cedro/cedar  
cèdre/zeder



**406**  
bruno/brown  
brun/braun



**006**  
nero/black  
noir/schwarz

colour on demand

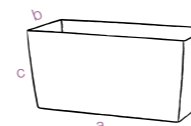

codice senza colore code without colour	Cm	dimensioni dimensions	litri liters	Confezione minima Minimum package	m <sup>3</sup>	pezzi pallet pcs pallet	m <sup>3</sup>
08 082 025	25	a26 b13 c12,5	4	12 28x28x34h	0,027	576 80x120x210h	2,02
08 082 030	30	a30 b15 c14	5	12 31x31x40h	0,038	432 80x120x210h	2,02

# linea BASIC

-  cilindro
-  campana
-  ciotola coste
-  vaso coste
-  ciotola con sottovaso
-  sottovaso
-  quadro
-  cassettone
-  sottovaso quadro
-  sottocassettone
-  cassetta mare
-  cassetta cortina
-  cassetta tirol
-  cassetta portofino
-  cassetta coste
-  sottocassetta



news  
2016



**407**  
salvia/sage  
saugé/salbei



**409**  
malva/mauve  
mauve/malve



**417**  
aluminium/aluminium  
aluminium/aluminium



**415**  
terra di Siena/terra di siena  
terra di siena/terra di siena



**414**  
fog grey/fog grey  
brouillard gris/Nebel grau



**Sottovaso**  
pagina 78

**Cilindro** colour

Superficie opaca  
Matt finished  
Surface opaque  
Matt-Oberfläche

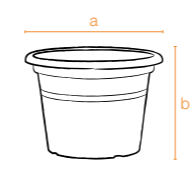
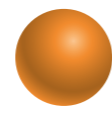

codice senza colore code without colour	Cm	dimensioni dimensions	litri liters		Confezione minima Minimum package	m <sup>3</sup>	pezzi pallet pcs pallet	m <sup>3</sup>
01 001 020	20	a20 b14,2	3	18	20 20x20x36h	0,014	1440 80x120x120h	1,15
01 001 025	25	a25 b17,7	5	22	10 25x25x30h	0,019	720 80x120x110h	1,06
01 001 030	30	a30 b21,2	9	26	10 30x30x34h	0,031	400 80x120x110h	1,06
01 001 035	35	a35 b24,6	13	30	10 35x35x39h	0,048	300 80x120x120h	1,15
01 001 040	40	a40 b27,2	19	35	10 40x40x42h	0,067	300 80x120x120h	1,15
01 001 045	45	a45 b31,4	29	40	10 45x45x46h	0,093	330 80x120x230h	2,21
01 001 050	50	a50 b34,9	41	45	5 50x50x42h	0,105	380 100x120x220h	2,64





## Cilindro colour

Superficie opaca / Matt finished  
Surface opaque / Matt-Oberfläche

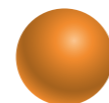

## Cilindro classic

Superficie opaca / Matt finished  
Surface opaque / Matt-Oberfläche

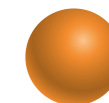

**022**

bianco/white  
blanc/weiß



**403**

corda/cord  
corde/seil



**406**

bruno/brown  
brun/braun



**408**

cacao/cocoa  
cacao/kakao



**018**

ciclamino/cyclamen  
cyclamen/zyklamfarbe



**019**

lilla/lilac  
lilas/lila



**404**

cedro/cedar  
cèdre/zeder



**Sottovaso**  
pagina 78



**001**

terracotta/terracotta colour  
couleur terre/farbe terrakotta



**005**

antracite/anthracite  
anthracite/anthrazitgrau



**Sottovaso**  
pagina 79

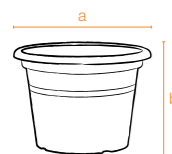

codice senza colore code without colour	Cm	dimensioni dimensions	litri liters	Confezione minima Minimum package	m <sup>3</sup>	pezzi pallet pcs pallet	m <sup>3</sup>
01 001 015	15	a15 b10,8	1	14	20	15x15x30h	0,007
01 001 018	18	a18 b12,8	2	16	20	18x18x32h	0,010
01 001 020	20	a20 b14,2	3	18	20	20x20x36h	0,014
01 001 025	25	a25 b17,7	5	22	10	25x25x30h	0,019
01 001 030	30	a30 b21,2	9	26	10	30x30x34h	0,031
01 001 035	35	a35 b24,6	13	30	10	35x35x39h	0,048
01 001 040	40	a40 b27,2	19	35	10	40x40x42h	0,067
01 001 045	45	a45 b31,4	29	40	10	45x45x46h	0,093
01 001 050	50	a50 b34,9	41	45	5	50x50x42h	0,105
01 001 060	60	a60 b41,8	69	52	5	60x60x50h	0,180
01 001 070	70	a70 b49	120	66	5	70x70x67h	0,328

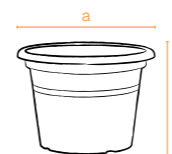

codice senza colore code without colour	Cm	dimensioni dimensions	litri liters	Confezione minima Minimum package	m <sup>3</sup>	pezzi pallet pcs pallet	m <sup>3</sup>
01 001 015	15	a15 b10,8	1	14	20	15x15x30h	0,007
01 001 018	18	a18 b12,8	2	16	20	18x18x32h	0,010
01 001 020	20	a20 b14,2	3	18	20	20x20x36h	0,014
01 001 025	25	a25 b17,7	5	22	10	25x25x30h	0,019
01 001 030	30	a30 b21,2	9	26	10	30x30x34h	0,031
01 001 035	35	a35 b24,6	13	30	10	35x35x39h	0,048
01 001 040	40	a40 b27,2	19	35	10	40x40x42h	0,067
01 001 045	45	a45 b31,4	29	40	10	45x45x46h	0,093
01 001 050	50	a50 b34,9	41	45	5	50x50x42h	0,105
01 001 060	60	a60 b41,8	69	52	5	60x60x50h	0,180
01 001 070	70	a70 b49	120	66	5	70x70x67h	0,328
01 001 090	90	a90 b63	260	88	5	90x90x82h	0,664



## Campana colour

Superficie opaca / Matt finished  
Surface opaque / Matt-Oberfläche

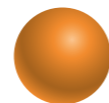

**022**

bianco/white  
blanc/weiß



**018**

ciclamino/cyclamen  
cyclamen/zyklamfarbe



**019**

lilla/lilac  
lilas/lila



**404**

cedro/cedar  
cèdre/zeder



**Sottovaso**  
pagina 78

codice senza colore code without colour	Cm	dimensioni dimensions	litri liters		Confezione minima Minimum package	m <sup>3</sup>	pezzi pallet pcs pallet		m <sup>3</sup>
01 002 020	20	a 20 b 13,8	2	18	20 20x20x40h	0,01	1080	80x120x113h	1,08
01 002 025	25	a 25 b 17,2	4	22	10 25x25x33h	0,02	600	80x120x115h	1,10

## Campana classic

Superficie opaca / Matt finished  
Surface opaque / Matt-Oberfläche

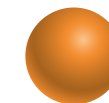

**001**

terracotta/terracotta colour  
couleur terre/farbe terrakotta



**005**

antracite/anthracite  
anthracite/anthrazitgrau



**Sottovaso**  
pagina 79

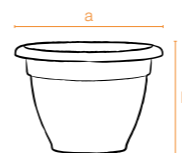
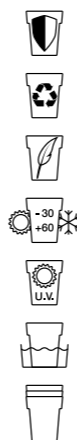

codice senza colore code without colour	Cm	dimensioni dimensions	litri liters		Confezione minima Minimum package	m <sup>3</sup>	pezzi pallet pcs pallet		m <sup>3</sup>
01 002 020	20	a 20 b 13,8	2	18	20 20x20x40h	0,01	1080	80x120x113h	1,08
01 002 025	25	a 25 b 17,2	4	22	10 25x25x33h	0,02	600	80x120x115h	1,10
01 002 030	30	a 30 b 20,7	8	26	10 30x30x37h	0,03	400	80x120x120h	1,15
01 002 035	35	a 35 b 24,1	12	30	10 35x35x41h	0,05	240	80x120x113h	1,08
01 002 040	40	a 40 b 26,8	17	35	10 40x40x45h	0,07	240	80x120x120h	1,15
01 002 045	45	a 45 b 31,1	26	40	10 45x45x51h	0,10	320	100x120x213h	2,56
01 002 050	50	a 50 b 34,6	35	45	5 50x50x45h	0,11	320	100x120x225h	2,70
01 002 060	60	a 60 b 41,4	60	52	5 60x60x53h	0,19	260	120x120x215h	2,58

# Ciotola coste

Superficie opaca / Matt finished  
Surface opaque / Matt-Oberfläche

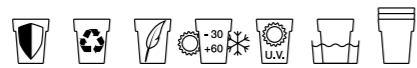
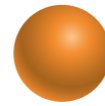

**001**

terracotta/terracotta colour  
couleur terre/farbe terrakotta



**005**

antracite/anthracite  
anthracite/anthrazitgrau

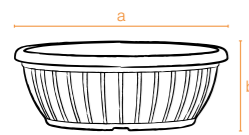

codice senza colore code without colour	Cm	dimensioni dimensions	litri liters	Confezione minima Minimum package	m <sup>3</sup>	pezzi pallet pcs pallet	m <sup>3</sup>
01 010 020	20	a20 b8	2	20 20x20x35h	0,01	1200 80x120x110h	1,06
01 010 025	25	a25 b9	3	10 25x25x25h	0,01	600 80x120x105h	1,01
01 010 030	30	a30 b11	5	10 30x30x29h	0,02	360 80x120x103h	0,99
01 010 035	35	a35 b12,5	8	10 35x35x31h	0,03	280 80x120x114h	1,09
01 010 040	40	a40 b14	12	10 40x40x38h	0,06	180 80x120x107h	1,03
01 010 050	50	a50 b18	24	10 50x50x43h	0,10	280 100x120x220h	2,64

# Ciotola con sottovaso

Superficie opaca / Matt finished  
Surface opaque / Matt-Oberfläche

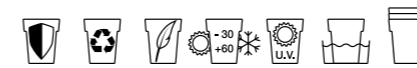
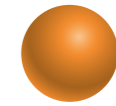

**001**

terracotta/terracotta colour  
couleur terre/farbe terrakotta



**005**

antracite/anthracite  
anthracite/anthrazitgrau

Il sottovaso è incluso e viene fissato ad incastro.  
The saucer is included and is fitted into.  
La soucoupe est inclus et est emboîtée dans.  
Der Untersetzer ist eingeschlossen und mit Clip-Funktion zusammengesteckt.

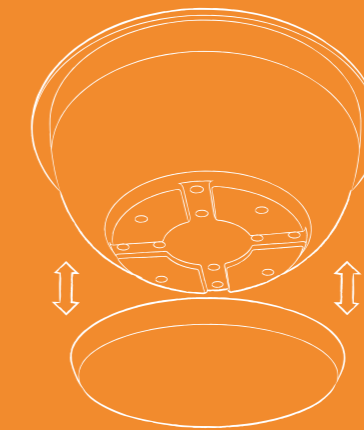

# Vaso coste

Superficie opaca / Matt finished  
Surface opaque / Matt-Oberfläche

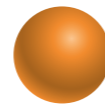

**001**

terracotta/terracotta colour  
couleur terre/farbe terrakotta



**005**

antracite/anthracite  
anthracite/anthrazitgrau

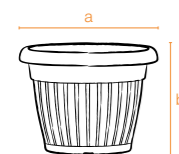

codice senza colore code without colour	Cm	dimensioni dimensions	litri liters	Confezione minima Minimum package	m <sup>3</sup>	pezzi pallet pcs pallet	m <sup>3</sup>
01 003 020	20	a20 b14,8	3	18 20x20x46h	0,01	1080 80x120x115h	1,10
01 003 025	25	a25 b18,4	5	22 10 25x25x52h	0,03	240 80x120x105h	1,01
01 003 030	30	a30 b21,8	8	26 10 30x30x56h	0,05	160 80x120x105h	1,01
01 003 035	35	a35 b25,7	13	30 10 35x35x59h	0,07	120 80x120x110h	1,06
01 003 040	40	a40 b29,4	20	35 10 40x40x61h	0,09	120 80x120x115h	1,10
01 003 045	45	a45 b33,1	29	40 10 45x45x64h	0,13	150 80x120x215h	2,06
01 003 050	50	a50 b36,8	40	45 5 50x50x51h	0,12	200 100x120x227h	2,72
01 003 060	60	a60 b44,1	70	52 5 60x60x58h	0,20	100 80x120x210h	2,11

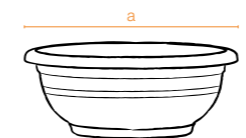

codice senza colore code without colour	Cm	dimensioni dimensions	Confezione minima Minimum package	m <sup>3</sup>	pezzi pallet pcs pallet	m <sup>3</sup>
01 009 030	30	a30 b11,5	incl 10 30x30x25h	0,02	400 80x120x105h	1,01
01 009 040	40	a40 b15,5	incl 10 40x40x32h	0,05	240 80x120x103h	0,99
01 009 050	50	a50 b18	incl 10 50x50x38h	0,09	360 100x120x212h	2,54

# Sottovaso colour

Superficie opaca / Matt finished  
Surface opaque / Matt-Oberfläche

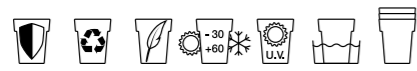
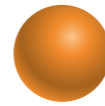

**022**  
bianco/white  
blanc/weiß



**403**  
corda/cord  
corde/seil



**406**  
bruno/brown  
brun/braun



**408**  
cacao/cocoa  
cacao/kakao



**018**  
ciclamino/cyclamen  
cyclamen/zyklamfarbe



**019**  
lilla/lilac  
lilas/lila



**404**  
cedro/cedar  
cèdre/zeder



**407**  
salvia/sage  
saugé/salbei



**409**  
malva/mauve  
mauve/malve



**417**  
aluminium/aluminium  
aluminium/aluminium



**415**  
terra di Siena/terra di siena  
terra di siena/terra di siena



**414**  
fog grey/fog grey  
brouillard gris/Nebel grau

codice senza colore code without colour	Cm	dimensioni dimensions	Confezione minima Minimum package	m <sup>3</sup>	pezzi pallet pcs pallet	m <sup>3</sup>
01 011 014	14	a14 b1,8	100	14x14x32h	0,006	2200
01 011 016	16	a16 b1,9	100	16x16x32h	0,008	1400
01 011 018	18	a18 b2,3	100	18x18x32h	0,010	1200
01 011 022	22	a22 b3	50	22x22x24h	0,012	600
01 011 026	26	a26 b3,7	50	26x26x24h	0,016	300
01 011 030	30	a30 b4,1	25	30x30x15h	0,014	200
01 011 035	35	a35 b5,1	25	35x35x15h	0,018	150
01 011 040	40	a40 b5,2	25	40x40x15h	0,024	125
01 011 045	45	a45 b5,5	24	45x45x17h	0,034	600
01 011 052	52	a52 b6,6	25	52x52x19h	0,051	350
01 011 066	66	a66 b6	5	66x66x9h	0,039	130

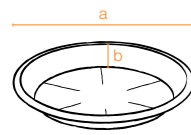

# Sottovaso classic

Superficie opaca / Matt finished  
Surface opaque / Matt-Oberfläche

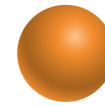

**001**  
terracotta/terracotta colour  
couleur terre/farbe terrakotta



**005**  
antracite/anthracite  
anthracite/anthrazitgrau

codice senza colore code without colour	Cm	dimensioni dimensions	Confezione minima Minimum package	m <sup>3</sup>	pezzi pallet pcs pallet	m <sup>3</sup>
01 011 012	12	a12 b1,5	100	12x12x28h	0,004	2800
01 011 014	14	a14 b1,8	100	14x14x32h	0,006	2200
01 011 016	16	a16 b1,9	100	16x16x32h	0,008	1400
01 011 018	18	a18 b2,3	100	18x18x32h	0,010	1200
01 011 020	20	a20 b2,9	50	20x20x20h	0,008	700
01 011 022	22	a22 b3	50	22x22x24h	0,012	600
01 011 024	24	a24 b3,6	50	24x24x20h	0,012	450
01 011 026	26	a26 b3,7	50	26x26x24h	0,016	300
01 011 028	28	a28 b4,1	50	28x28x24h	0,019	300
01 011 030	30	a30 b4,1	25	30x30x15h	0,014	200
01 011 035	35	a35 b5,1	25	35x35x15h	0,018	150
01 011 040	40	a40 b5,2	25	40x40x15h	0,024	125
01 011 045	45	a45 b5,5	24	45x45x17h	0,034	600
01 011 052	52	a52 b6,6	25	52x52x19h	0,051	350
01 011 066	66	a66 b6	5	66x66x9h	0,039	130
01 011 088	88	a88 b6,6	5	88x88x10h	0,077	130

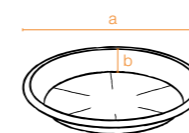





## Quadro colour

Superficie opaca / Matt finished  
Surface opaque / Matt-Oberfläche

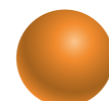

**403**  
corda/cord  
corde/seil



**406**  
bruno/brown  
brun/braun



**408**  
cacao/cocoa  
cacao/kakao



**Sottovaso**  
pagina 84

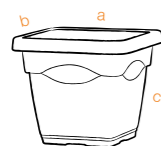
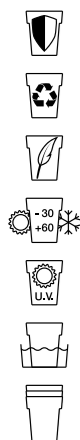

codice senza colore code without colour	Cm	dimensioni dimensions	litri liters		Confezione minima Minimum package	m <sup>3</sup>	pezzi pallet pcs pallet		m <sup>3</sup>
01 007 032	32	a32 b32 c28	14	27	10 32x32x49h	0,05	210	80x120x115h	1,10
01 007 038	38	a38 b38 c33,5	25	33	10 38x38x56h	0,08	180	80x120x110h	1,06
01 007 045	45	a45 b45 c40	42	38	10 45x45x69h	0,14	200	100x120x212h	2,54

## Quadro classic

Superficie opaca / Matt finished  
Surface opaque / Matt-Oberfläche

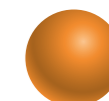

**001**  
terracotta/terracotta colour  
couleur terre/farbe terracotta



**005**  
antracite/anthracite  
anthracite/anthrazitgrau



**Sottovaso**  
pagina 84

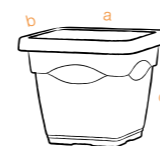
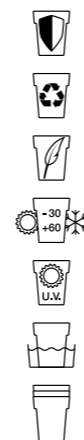

codice senza colore code without colour	Cm	dimensioni dimensions	litri liters		Confezione minima Minimum package	m <sup>3</sup>	pezzi pallet pcs pallet		m <sup>3</sup>
01 007 032	32	a32 b32 c28	14	27	10 32x32x49h	0,05	210	80x120x115h	1,10
01 007 038	38	a38 b38 c33,5	25	33	10 38x38x56h	0,08	180	80x120x110h	1,06
01 007 045	45	a45 b45 c40	42	38	10 45x45x69h	0,14	200	100x120x212h	2,54



## Cassettone colour

Superficie opaca / Matt finished  
Surface opaque / Matt-Oberfläche

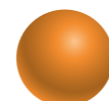

**403**

corda/cord  
corde/seil



**406**

bruno/brown  
brun/braun



**408**

cacao/cocoa  
cacao/kakao

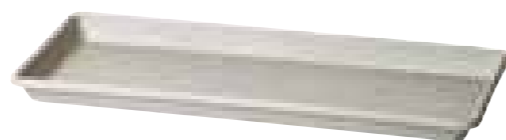

**Sottocassettone**  
pagina 85

codice senza colore code without colour	Cm	dimensioni dimensions	litri liters	Confezione minima Minimum package	m <sup>3</sup>	pezzi pallet pcs pallet	m <sup>3</sup>
01 008 060	60	a60 b32 c27,5	31	60x32x37h	0,07	420	100x120x224h 2,69
01 008 080	80	a80 b37 c32,8	60	80x37x43h	0,12	210	80x120x224h 2,15
01 008 100	100	a100b40 c37,5	92	100x40x54h	0,21	100	100x120x228h 2,74

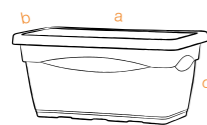

## Cassettone classic

Superficie opaca / Matt finished  
Surface opaque / Matt-Oberfläche

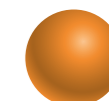

**001**

terracotta/terracotta colour  
couleur terre/farbe terrakotta



**005**

antracite/anthracite  
anthracite/anthrazitgrau

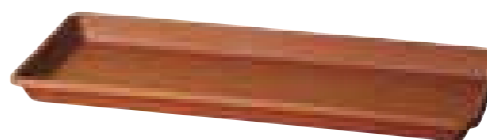

**Sottocassettone**  
pagina 85

codice senza colore code without colour	Cm	dimensioni dimensions	litri liters	Confezione minima Minimum package	m <sup>3</sup>	pezzi pallet pcs pallet	m <sup>3</sup>
01 008 060	60	a60 b32 c27,5	31	60x32x37h	0,07	420	100x120x224h 2,69
01 008 080	80	a80 b37 c32,8	60	80x37x43h	0,12	210	80x120x224h 2,15
01 008 100	100	a100b40 c37,5	92	100x40x54h	0,21	100	100x120x228h 2,74

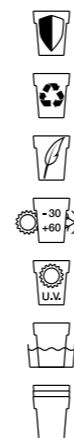
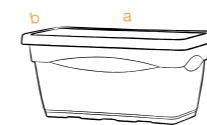

# Sottovaso Quadro colour

Superficie opaca / Matt finished  
Surface opaque / Matt-Oberfläche

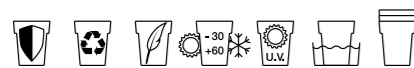
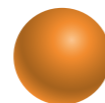

**403**  
corda/cord  
corde/seil

**406**  
bruno/brown  
brun/braun

**408**  
cacao/cocoa  
cacao/kakao

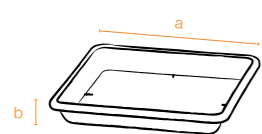

codice senza colore code without colour	Cm	dimensioni dimensions	Confezione minima Minimum package	m <sup>3</sup>	pezzi pallet pcs pallet	m <sup>3</sup>
01 013 027	27	a27 b4	10 27x27x11h	0,01	140 60x40x50h	0,12
01 013 033	33	a33 b5	10 33x33x13h	0,01	70 60x40x50h	0,12
01 013 038	38	a37,5 b6	10 38x38x16h	0,02	50 60x40x50h	0,12

# Sottocassettone colour

Superficie opaca / Matt finished  
Surface opaque / Matt-Oberfläche

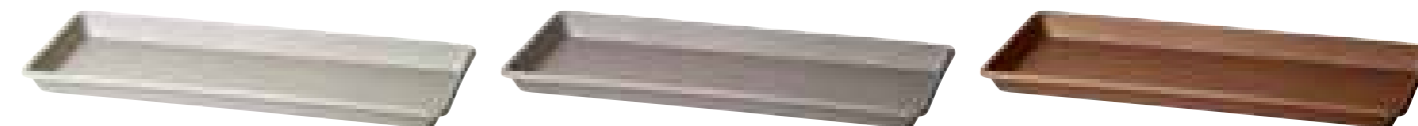
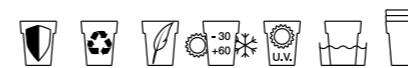
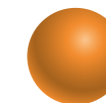

**403**  
corda/cord  
corde/seil

**406**  
bruno/brown  
brun/braun

**408**  
cacao/cocoa  
cacao/kakao

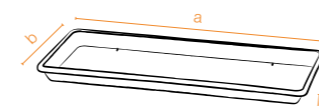

codice senza colore code without colour	Cm	dimensioni dimensions	Confezione minima Minimum package	m <sup>3</sup>	pezzi pallet pcs pallet	m <sup>3</sup>
01 014 060	60	a56 b28 a4,3	5 56x28x7h	0,01	60 60x40x50h	0,12
01 014 080	80	a75 b32 a5,1	5 75x33x9h	0,02	285 80x120x115h	1,10
01 014 100	100	a95 b35 a5,2	5 95x35x11h	0,03	160 80x120x115h	1,10

# Sottovaso Quadro

Superficie opaca / Matt finished  
Surface opaque / Matt-Oberfläche

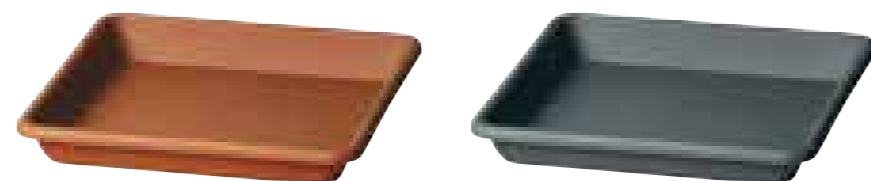
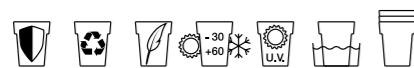
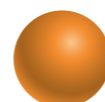

**001**  
terracotta/terracotta colour  
couleur terre/farbe terrakotta

**005**  
antracite/anthracite  
anthracite/anthrazitgrau

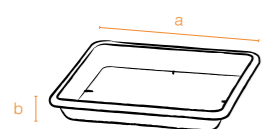

codice senza colore code without colour	Cm	dimensioni dimensions	Confezione minima Minimum package	m <sup>3</sup>	pezzi pallet pcs pallet	m <sup>3</sup>
01 013 027	27	a27 b4	10 27x27x11h	0,01	140 60x40x50h	0,12
01 013 033	33	a33 b5	10 33x33x13h	0,01	70 60x40x50h	0,12
01 013 038	38	a37,5 b6	10 38x38x16h	0,02	50 60x40x50h	0,12

# Sottocassettone

Superficie opaca / Matt finished  
Surface opaque / Matt-Oberfläche

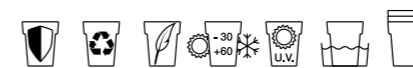
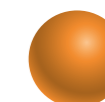

**001**  
terracotta/terracotta colour  
couleur terre/farbe terrakotta

**005**  
antracite/anthracite  
anthracite/anthrazitgrau

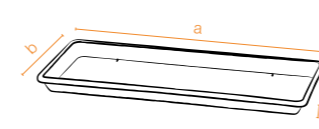

codice senza colore code without colour	Cm	dimensioni dimensions	Confezione minima Minimum package	m <sup>3</sup>	pezzi pallet pcs pallet	m <sup>3</sup>
01 014 060	60	a56 b28 a4,3	5 56x28x7h	0,01	60 60x40x50h	0,12
01 014 080	80	a75 b32 a5,1	5 75x33x9h	0,02	285 80x120x115h	1,10
01 014 100	100	a95 b35 a5,2	5 95x35x11h	0,03	160 80x120x115h	1,10

news  
2016



**407**  
salvia/sage  
sauge/salbei

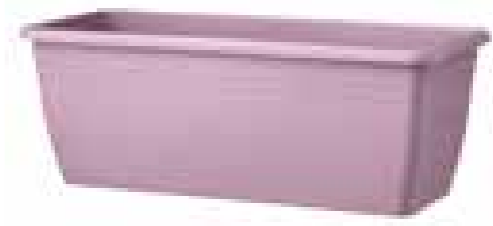

**409**  
malva/mauve  
mauve/malve



**417**  
aluminium/aluminium  
aluminium/aluminium



**415**  
terra di Siena/terra di siena  
terra di siena/terra di siena



**414**  
fog grey/fog grey  
brouillard gris/Nebel grau

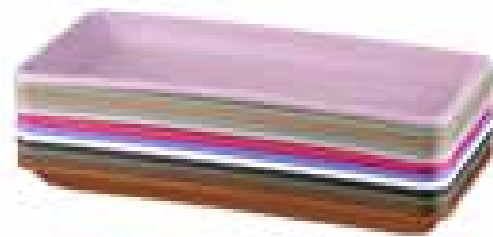

**Sottocassetta**  
pagina 98

**Cassetta mare** new colour

Superficie opaca  
Matt finished  
Surface opaque  
Matt-Oberfläche

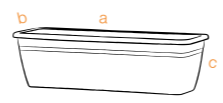
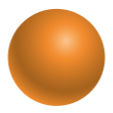

codice senza colore code without colour	Cm	dimensioni dimensions	litri liters	Confezione minima Minimum package	m <sup>3</sup>	pezzi pallet pcs pallet	m <sup>3</sup>	accessori accessories
01 004 040	40	a40 b17 c14,5	6	10 40x17x30h	0,02	700 80x120x115h	1,10	
01 004 050	50	a50 b17 c14,5	8	10 50x17x30h	0,02	450 80x120x118h	1,13	
01 004 060	60	a60 b17 c14,5	10	10 60x17x30h	0,03	450 80x120x115h	1,10	





## Cassetta mare colour

Superficie opaca / Matt finished  
Surface opaque / Matt-Oberfläche

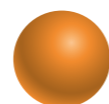

## Cassetta mare classic

Superficie opaca / Matt finished  
Surface opaque / Matt-Oberfläche

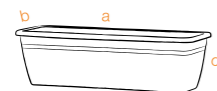
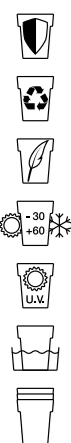
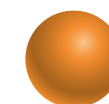

codice senza colore code without colour	Cm	dimensioni dimensions	litri liters	Cofezione minima Minimum package	m <sup>3</sup>	pezzi pallet pcs pallet	m <sup>3</sup>	accessori accessories
01 004 040	40	a40 b17 c14,5	6	10 40x17x30h	0,02	700 80x120x115h	1,10	
01 004 050	50	a50 b17 c14,5	8	10 50x17x30h	0,02	450 80x120x118h	1,13	
01 004 060	60	a60 b17 c14,5	10	10 60x17x30h	0,03	450 80x120x115h	1,10	
01 004 080	80	a80 b17 c14,5	12	10 80x17x30h	0,04	240 80x120x105h	1,01	

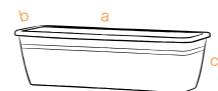
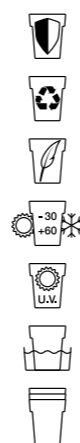

codice senza colore code without colour	Cm	dimensioni dimensions	litri liters	Cofezione minima Minimum package	m <sup>3</sup>	pezzi pallet pcs pallet	m <sup>3</sup>	accessori accessories
01 004 040	40	a40 b17 c14,5	6	10 40x17x30h	0,02	700 80x120x115h	1,10	
01 004 050	50	a50 b17 c14,5	8	10 50x17x30h	0,02	450 80x120x118h	1,13	
01 004 060	60	a60 b17 c14,5	10	10 60x17x30h	0,03	450 80x120x115h	1,10	
01 004 080	80	a80 b17 c14,5	12	10 80x17x30h	0,04	240 80x120x105h	1,01	

**Sottocassetta**  
pagina 99

**Sottocassetta**  
pagina 98



## Cassetta Cortina colour

Superficie opaca / Matt finished  
Surface opaque / Matt-Oberfläche

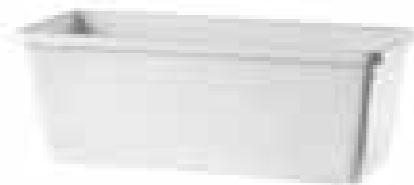
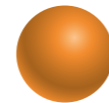

**022**  
bianco/white  
blanc/weiß



**406**  
bruno/brown  
brun/braun



**018**  
ciclamo/cyclamen  
cyclamen/zyklamfarbe



**404**  
cedro/cedar  
cèdre/zeder



**Sottocassetta**  
pagina 98

codice senza colore code without colour	Cm	dimensioni dimensions	litri liters	litri liters	Confezione minima Minimum package	m <sup>3</sup>	pezzi pallet pcs pallet	m <sup>3</sup>
01 104 040	40	a40 b18 c14	10	40	5 40x18x22h	0,01	480 80x120x106h	1,08
01 104 060	60	a60 b18 c14	15	60	5 60x18x22h	0,02	320 80x120x106h	1,08
01 104 080	80	a80 b18 c14	20	80	5 80x18x22h	0,03	240 80x120x106h	1,08
01 104 100	100	a100 b18 c14	25	100	5 100x18x22h	0,04	160 80x120x106h	1,08



## Cassetta Cortina classic

Superficie opaca / Matt finished  
Surface opaque / Matt-Oberfläche

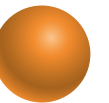

**001**  
terracotta/terracotta colour  
couleur terre/farbe terrakotta



**005**  
antracite/anthracite  
anthracite/anthrazitgrau

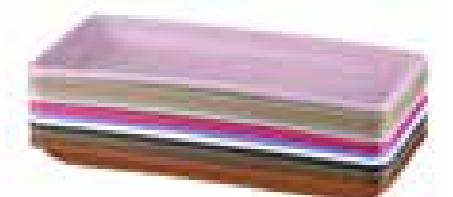

**Sottocassetta**  
pagina 98

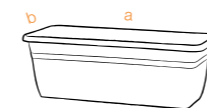
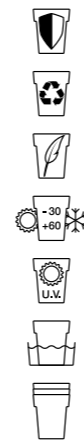

codice senza colore code without colour	Cm	dimensioni dimensions	litri liters	litri liters	Confezione minima Minimum package	m <sup>3</sup>	pezzi pallet pcs pallet	m <sup>3</sup>
01 104 040	40	a40 b18 c14	10	40	5 40x18x22h	0,01	480 80x120x106h	1,08
01 104 060	60	a60 b18 c14	15	60	5 60x18x22h	0,02	320 80x120x106h	1,08
01 104 080	80	a80 b18 c14	20	80	5 80x18x22h	0,03	240 80x120x106h	1,08
01 104 100	100	a100 b18 c14	25	100	5 100x18x22h	0,04	160 80x120x106h	1,08

# Cassetta Tirol

Superficie opaca / Matt finished  
Surface opaque / Matt-Oberfläche

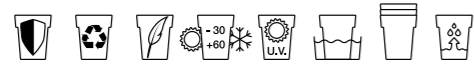
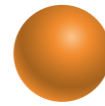

la cassetta tirol ha un ottimo litraggio  
cassetta tirol has a big soil reserve  
cassetta tirol a une grande réserve de terre  
Balkonkasten Tirol enthält einen guten Erdevorrat



**001**

terracotta/terracotta colour  
couleur terre/farbe terrakotta



**005**

antracite/anthracite  
anthracite/anthrazitgrau



**Sottocassetta**  
pagina 98

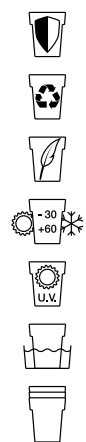

codice senza colore code without colour	Cm	dimensioni dimensions	litri liters	Confezione minima Minimum package	m <sup>3</sup>	pezzi pallet pcs pallet	m <sup>3</sup>
01 006 040	40	a40 b20 c16	8	10 40x20x31h	0,02	720 80x120x118h	1,13
01 006 050	50	a50 b20 c16	11	10 50x20x31h	0,03	540 80x120x118h	1,13
01 006 060	60	a60 b20 c16	13	10 60x20x31h	0,03	480 80x120x115h	1,10

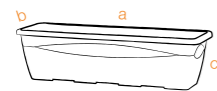

LINEA BASIC

# Cassetta Portofino colour

Superficie opaca / Matt finished  
Surface opaque / Matt-Oberfläche

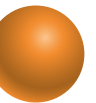

misure 80 - 100  
sizes 80 - 100

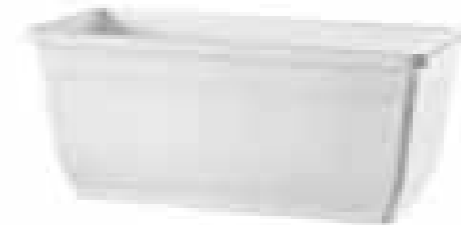

**022**

bianco/white  
blanc/weiß



**406**

bruno/brown  
brun/braun



**018**

ciclamino/cyclamen  
cyclamen/zyklamfarbe



**404**

cedro/cedar  
cèdre/zeder

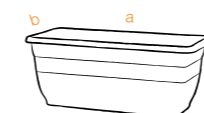

codice senza colore code without colour	Cm	dimensioni dimensions	litri liters	Confezione minima Minimum package	m <sup>3</sup>	pezzi pallet pcs pallet	m <sup>3</sup>
01 105 040	40	a40 b20 c16,5	13	5 40x20x32h	0,02	240 80x120x110h	1,06
01 105 060	60	a60 b20 c16,5	20	5 60x20x32h	0,03	160 80x120x110h	1,06
01 105 080	80	a80 b20 c16,5	26	5 80x20x32h	0,05	120 80x120x110h	1,06
01 105 100	100	a100 b20 c16,5	33	5 100x20x32h	0,06	80 80x120x110h	1,06



# Cassetta Portofino classic

Superficie opaca / Matt finished  
Surface opaque / Matt-Oberfläche

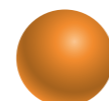

**001**  
terracotta/terracotta colour  
couleur terre/farbe terrakotta



**005**  
antracite/anthracite  
anthracite/anthrazitgrau

misure 80 - 100  
sizes 80 - 100



codice senza colore code without colour	Cm	dimensioni dimensions			litri liters	Confezione minima Minimum package	m <sup>3</sup>	pezzi pallet pcs pallet	m <sup>3</sup>
01 105 040	40	a40	b20	c16,5	13	5 40x20x32h	0,02	240 80x120x110h	1,06
01 105 060	60	a60	b20	c16,5	20	5 60x20x32h	0,03	160 80x120x110h	1,06
01 105 080	80	a80	b20	c16,5	26	5 80x20x32h	0,05	120 80x120x110h	1,06
01 105 100	100	a100	b20	c16,5	33	5 100x20x32h	0,06	80 80x120x110h	1,06

diffusione dell'acqua per osmosi  
water diffusion through osmosis's effect  
diffusion de l'eau par osmose  
Wasserdiffusion durch Osmose

beccuccio per inserimento dell'acqua  
spout for water insertion  
bec pour l'introduction de l'eau  
Füllschacht zur Wasserversorgung

foro di drenaggio per l'acqua in eccesso  
drainage bore for water's excess  
trou de drainage pour l'eau en excès  
Entwässerungsloch

riserva d'acqua  
water reserve  
réserve d'eau  
Wasser-Reservoir

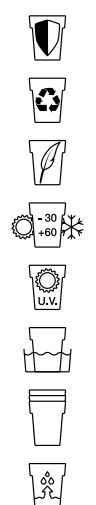
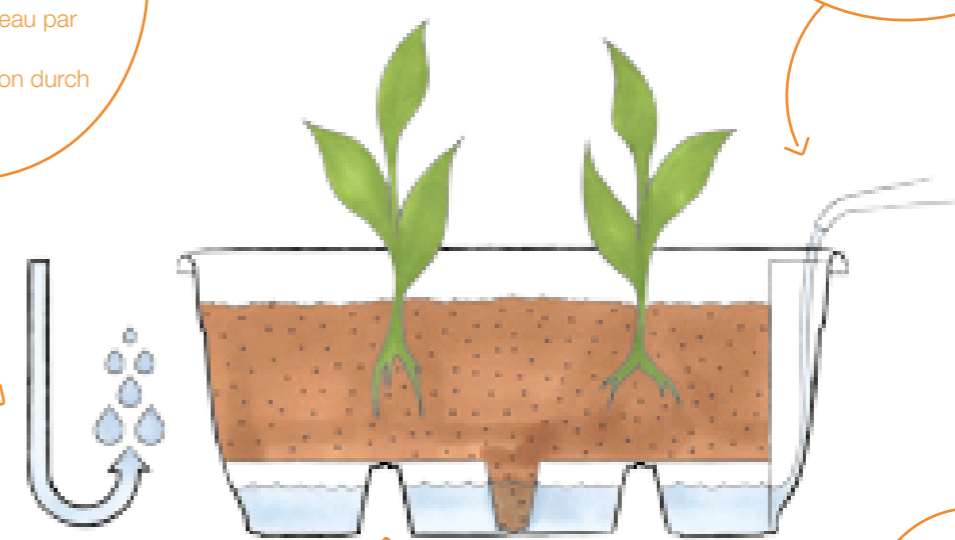



# Cassetta coste

Superficie opaca / Matt finished  
Surface opaque / Matt-Oberfläche

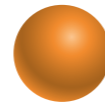

**001**

terracotta/terracotta colour  
couleur terre/farbe terrakotta



**005**

antracite/anthracite  
anthracite/anthrazitgrau

diffusione dell'acqua per osmosi  
water diffusion through osmosis's effect  
diffusion de l'eau par osmose  
Wasserdiffusion durch Osmose

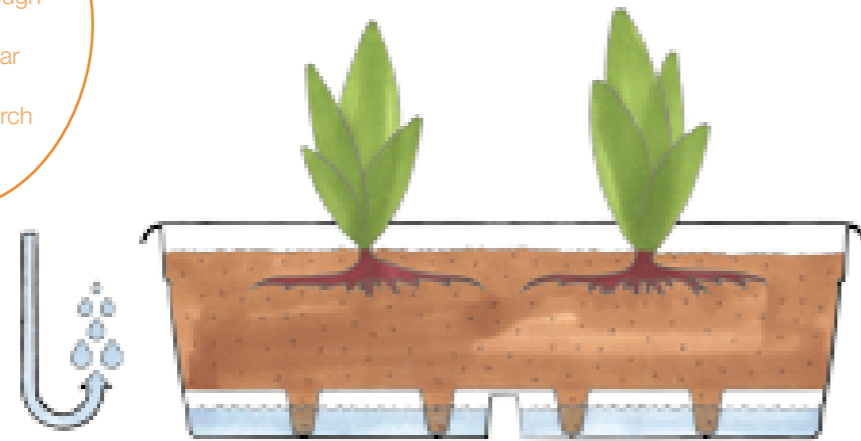

riserva d'acqua  
water reserve  
réserve d'eau  
Wasser-Reservoir

supporto coste  
pagina 97

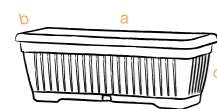
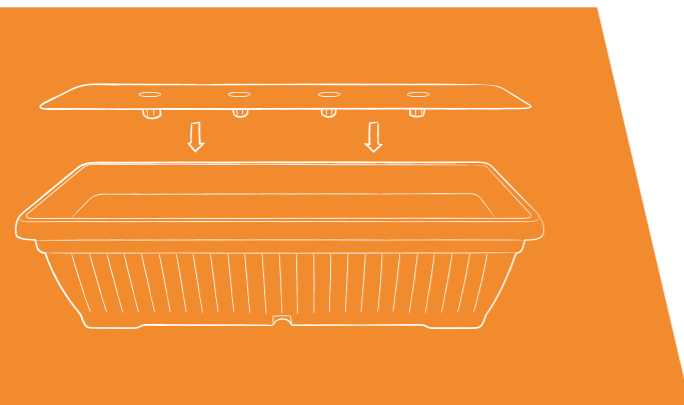

codice senza colore code without colour	Cm	dimensioni dimensions	litri liters	Confezione minima Minimum package	m <sup>3</sup>	pezzi pallet pcs pallet	m <sup>3</sup>	accessori accessories
01 005 040	40	a40 b20 c17	8	10 40x20x43h	0,03	360 80x120x115h	1,10	
01 005 050	50	a50 b20 c17	11	10 50x20x43h	0,04	270 80x120x115h	1,10	
01 005 060	60	a60 b20 c17	13	10 60x20x43h	0,05	240 80x120x118h	1,13	

# kit balcone Coste

Superficie opaca / Matt finished  
Surface opaque / Matt-Oberfläche

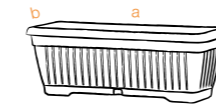
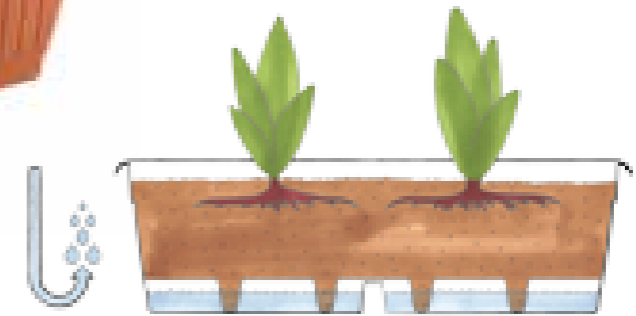
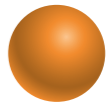

codice senza colore code without colour	Cm	dimensioni dimensions	Confezione minima Minimum package	m <sup>3</sup>	pezzi pallet pcs pallet	m <sup>3</sup>
01 016 040	40	a40 b27 c17,3	104 80x60x115h	0,55	224 80x120x115h	1,10
01 016 050	50	a50 b20 c17,3	78 80x60x115h	0,55	168 80x120x115h	1,10
01 016 060	60	a60 b20 c17,3	78 80x60x115h	0,55	168 80x120x115h	1,10

## supporto Coste

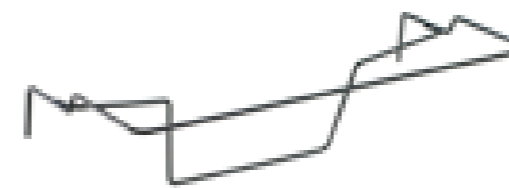

codice senza colore code without colour	Cm	Confezione minima Minimum package	m <sup>3</sup>
10 901 040	40	10 40x28x30h	0,03
10 901 050	50	10 50x28x30h	0,04
10 901 060	60	10 60x28x30h	0,05

## supporto Mare

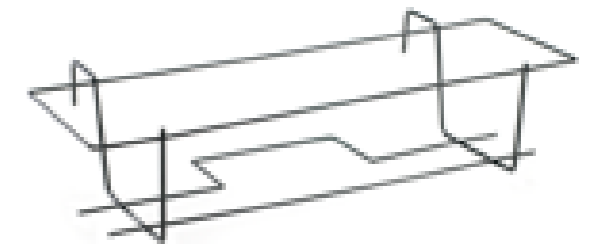

codice senza colore code without colour	Cm	Confezione minima Minimum package	m <sup>3</sup>
10 900 040	40	10 46x30x24h	0,03
10 900 050	50	10 56x30x24h	0,04
10 900 060	60	10 66x30x24h	0,04
10 900 080	80	10 86x30x24h	0,06



## Sottocassetta colour

Superficie opaca / Matt finished  
Surface opaque / Matt-Oberfläche

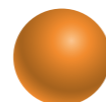

## Sottocassetta classic

Superficie opaca / Matt finished  
Surface opaque / Matt-Oberfläche

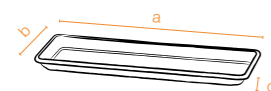
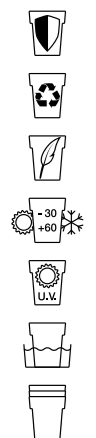
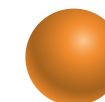

codice senza colore code without colour	Cm	dimensioni dimensions	litri liters	Confezione minima Minimum package	m <sup>3</sup>	pezzi pallet pcs pallet	m <sup>3</sup>
<b>01 012 040</b>	40	a38 b19 c3,2	2	10 38x19x15h	0,01	240	60x40x50h 0,12
<b>01 012 050</b>	50	a48 b19 c3,2	3	10 48x19x15h	0,01	160	60x40x50h 0,12
<b>01 012 060</b>	60	a58 b19 c3,2	5	10 58x19x15h	0,01	160	60x40x50h 0,12
<b>01 012 080</b>	80	a78 b19 c3,2	8	10 78x19x15h	0,02	1080	80x120x115h 1,10
<b>01 012 100</b>	100	a98 b19 c3,2	10	10 98x19x15h	0,02	720	80x115x115h 1,10

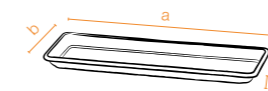
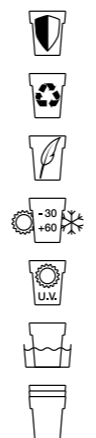

codice senza colore code without colour	Cm	dimensioni dimensions	litri liters	Confezione minima Minimum package	m <sup>3</sup>	pezzi pallet pcs pallet	m <sup>3</sup>
<b>01 012 040</b>	40	a38 b19 c3,2	2	10 38x19x15h	0,01	240	60x40x50h 0,12
<b>01 012 050</b>	50	a48 b19 c3,2	3	10 48x19x15h	0,01	160	60x40x50h 0,12
<b>01 012 060</b>	60	a58 b19 c3,2	5	10 58x19x15h	0,01	160	60x40x50h 0,12
<b>01 012 080</b>	80	a78 b19 c3,2	8	10 78x19x15h	0,02	1080	80x120x115h 1,10
<b>01 012 100</b>	100	a98 b19 c3,2	10	10 98x19x15h	0,02	720	80x115x115h 1,10

disponibile anche:  
also available:  
aussi disponible:  
verfügbar auch:

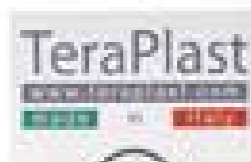
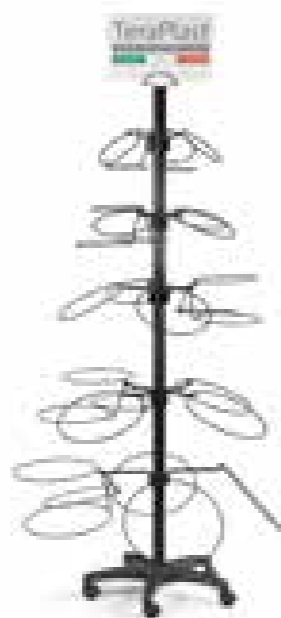
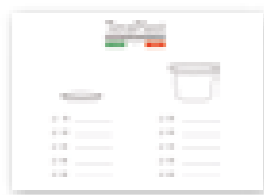

## Display

### Espositore cilindri e sottovasi

Codice ESPOSITORE:  
Code for empty Cilinder and saucers display:  
Code du présentoir vide pour les Cylindres:  
Code für den leeren Ständer der Zylinder und Untersetzer:  
**10915830000**

L'espositore è adatto per contenere i nostri articoli CILINDRO INIEZIONE e SOTTOVASO INIEZIONE nelle seguenti misure e quantità:  
The Display is suitable to hold our ITEMS CYLINDER INJECTION AND SAUCER INJECTION in the following sizes and quantities:

Le présentoir est apte à contenir nos articles CYLINDRE INJECTÉ et SOUCOUPES dans les tailles et quantités suivantes:

Der Präsentationsständer ist für unseren Artikel INJEKTION ZYLINDER TOPF und UNTERSETZER RUND in den folgenden Größen und Mengen als Behälter geeignet:

codice senza colore code without colour	descrizione	quantità consigliata	minimo vendita per colore
01 001 020	Cilindro cm 20	10	20
01 001 025	Cilindro cm 25	10	10
01 001 030	Cilindro cm 30	20	10
01 001 035	Cilindro cm 35	10	10
01 001 040	Cilindro cm 40	5	10

codice senza colore code without colour	descrizione	quantità minima	minimo vendita per colore
01 011 018	Sottovaso cm 18	10	100
01 011 022	Sottovaso cm 22	10	50
01 011 026	Sottovaso cm 26	20	50
01 011 030	Sottovaso cm 30	10	25
01 011 035	Sottovaso cm 35	5	25

### Espositore cassette e sottocassette

Codice ESPOSITORE:  
Code for empty Balcony boxes and saucers display:  
Code du présentoir vide pour les cylindres et les soucoupes  
Code für den leeren Ständer von Zylinder und Untersetzer  
**10918830000**

L'espositore è adatto per contenere le CASSETTE e LE SOTTOCASSETTE INIEZIONE nelle seguenti misure e quantità:  
The Display is suitable to contain our items BALCONY BOXES INJECTION AND SAUCER INJECTION in the following sizes and quantities:

Le présentoir est apte à contenir nos articles CYLINDRE INJECTÉ et SOUCOUPES dans les tailles et quantités suivantes:

Der Präsentationsständer ist für unseren Artikel INJEKTION ZYLINDER TOPF und UNTERSETZER RUND in folgenden Größen und Mengen als Behälter geeignet:

codice senza colore code without colour	descrizione	quantità consigliata	minimo vendita per colore
01 004 040	Cassetta cm 40	10	10
01 004 050	Cassetta cm 50	10	10
01 004 060	Cassetta cm 60	10	10
01 004 080	Cassetta cm 80	5	10

codice senza colore code without colour	descrizione	quantità consigliata	minimo vendita per colore
01 012 040	Sottocassetta cm 40	10	10
01 012 050	Sottocassetta cm 50	10	10
01012060	Sottocassetta cm 60	10	10
01 012 080	Sottocassetta cm 80	5	10

disponibile anche:  
also available:  
aussi disponible:  
verfügbar auch:

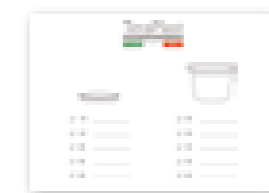

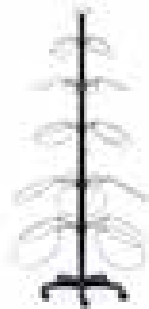
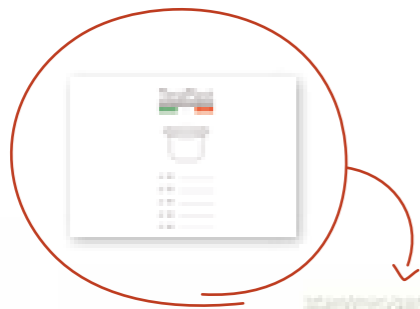

codice senza colore code without colour	descrizione	quantità consigliata	minimo vendita per colore
01 001 020	Cilindro cm 20	40	20
01 001 025	Cilindro cm 25	40	10
01 001 030	Cilindro cm 30	40	10
01 001 035	Cilindro cm 35	40	10
01 001 040	Cilindro cm 40	40	10

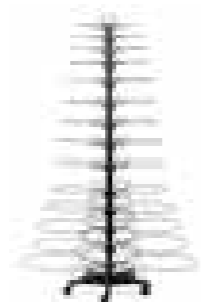

codice senza colore code without colour	descrizione	quantità consigliata	minimo vendita per colore
01 011 012	Sottovaso cm 12	100	100
01 011 014	Sottovaso cm 14	100	100
01 011 016	Sottovaso cm 13	100	100
01 011 018	Sottovaso cm 18	50	100
01 011 020	Sottovaso cm 20	50	50
01 011 022	Sottovaso cm 22	50	50
01 011 024	Sottovaso cm 24	50	50
01 011 026	Sottovaso cm 26	50	50
01 011 028	Sottovaso cm 28	50	50
01 011 030	Sottovaso cm 30	50	25
01 011 035	Sottovaso cm 35	50	25
01 011 040	Sottovaso cm 40	50	25
01 011 045	Sottovaso cm 45	50	25
01 011 052	Sottovaso cm 52	50	25

## Espositore cilindri vuoto

Codice ESPOSITORE CILINDRI VUOTO:  
Code for empty Cylinder display:  
Code du présentoir vide pour les Cylindres:  
Code für den leeren Ständer der Zylinder:  
**10911830000**

L'espositore è adatto per contenere il nostro articolo CILINDRO INIEZIONE nelle seguenti misure e quantità:

The Display is suitable to hold our article CYLINDER INJECTION in the following sizes and quantities:

Le présentoir est apte à contenir notre article CYLINDRE INJECTÉ dans les tailles et quantités suivantes:

Der Präsentationsständer ist für unseren Artikel INJEKTION ZYLINDER TOPF in den folgenden Größen und Mengen als Behälter geeignet:

## Espositore sottovasi vuoto

Codice ESPOSITORE SOTTOVASI VUOTO:  
Code for empty Saucer Display:  
Code du présentoir vide pour les Soucoupes:  
Code für den leeren Ständer der Untersetzer:  
**10909830000**

L'espositore è adatto per contenere il nostro articolo SOTTOVASO ROTONDO INIEZIONE nelle seguenti misure e quantità:

The Display is suitable to hold our article ROUND SAUCER INJECTION in the following sizes and quantities:

Le présentoir est apte à contenir notre article SOUCOUE RONDE INJECTÉE dans les tailles et quantités suivantes:

Der Präsentationsständer ist für unseren Artikel INJEKTION UNTERSETZER RUND in den folgenden Größen und Mengen als Behälter geeignet:

## Marketing support

TeraPlast può aiutarti anche per quanto riguarda il punto vendita, offrendo una grande varietà di display e scaffalature espositive. Sono soluzioni ideali perché sono maneggevoli e attrattive per il consumatore finale. Richiedi il nostro catalogo tecnico!

TeraPlast may help you also concerning shops, offering a wide range of display solutions and shelves. They are ideal solutions, because they are manageable and eye catching for consumers. Ask for our technical catalogue!

TeraPlast may help you also concerning shops, offering a wide range of display solutions and shelves. They are ideal solutions, because they are manageable and eye catching for consumers. Ask for our technical catalogue!

TeraPlast may help you also concerning shops, offering a wide range of display solutions and shelves. They are ideal solutions, because they are manageable and eye catching for consumers. Ask for our technical catalogue!





# display kit balcone **Mare** 1 pz

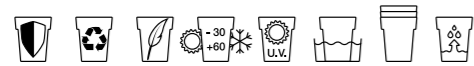

**022**  
bianco/white  
blanc/weiß

**403**  
corda/cord  
corde/seil

**406**  
bruno/brown  
brun/braun

**408**  
cacao/cocoa  
cacao/kakao



**018**  
ciclaminò/cyclamen  
cyclamen/zyklamfarbe

**019**  
lilla/lilac  
lilas/lila

**404**  
cedro/cedar  
cèdre/zeder



**001**  
terracotta/terracotta colour  
couleur terre/farbe terrakotta

**005**  
antracite/anthracite  
anthracite/anthrazitgrau

codice senza colore code without colour	Cm	dimensioni dimensions	pezzi pallet pcs pallet	m <sup>3</sup>
01 015 040	40	a40 b17 c14,5	48	80x120x115h 1,10
01 015 050	50	a50 b17 c14,5	42	80x120x115h 1,10
01 015 060	60	a60 b17 c14,5	35	80x120x115h 1,10
01 015 080	80	a80 b17 c14,5	24	80x120x105h 1,10

# display kit balcone **Mare** 2 pz

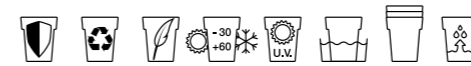

**022**  
bianco/white  
blanc/weiß

**403**  
corda/cord  
corde/seil

**406**  
bruno/brown  
brun/braun

**408**  
cacao/cocoa  
cacao/kakao



**018**  
ciclaminò/cyclamen  
cyclamen/zyklamfarbe

**019**  
lilla/lilac  
lilas/lila

**404**  
cedro/cedar  
cèdre/zeder



**001**  
terracotta/terracotta colour  
couleur terre/farbe terrakotta

**005**  
antracite/anthracite  
anthracite/anthrazitgrau

codice senza colore code without colour	Cm	dimensioni dimensions	pezzi pallet pcs pallet	m <sup>3</sup>
01 019 040	40	a40 b17 c14,5	40	80x120x115h 1,10
01 019 050	50	a50 b17 c14,5	35	80x120x115h 1,10
01 019 060	60	a60 b17 c14,5	25	80x120x115h 1,10
01 019 080	80	a80 b17 c14,5	18	80x120x115h 1,10

# T-BASKET



t-basket



t-basket big





**T-Basket**

Superficie opaca  
Matt finished  
Surface opaque  
Matt-Oberfläche

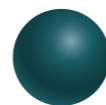

ideale per contenere  
3 vasi da 14 cm  
Ideal for containing  
3 pots of 14 cms  
Idéal pour contenir 3  
vases à 14 cm  
Ideal um 3 Vasen à  
14cm zu fassen

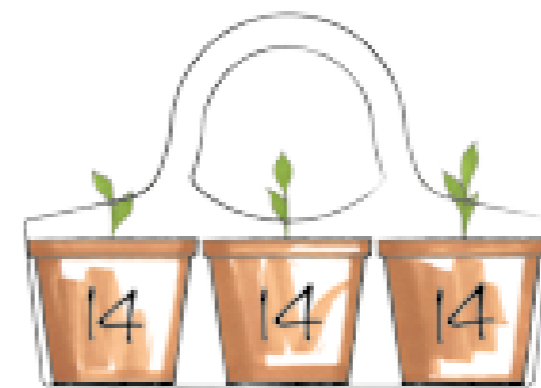

Linea **Flortec**  
pagina 112



**022**  
bianco/white  
blanc/weiß



**010**  
rosso/red  
rouge/rot



**419**  
giallo/yellow  
jaune/gelb



**402**  
lilyum/lilyum  
lilyum/lilyum



**404**  
cedro/cedar  
cèdre/zeder



**415**  
terra di Siena/terra di siena  
terra di siena/terra di siena

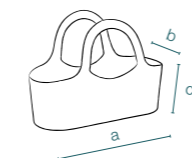

codice senza colore code without colour	Cm	dimensioni dimensions	pezzi pallet pcs pallet	m <sup>3</sup>
<b>BOX 1 COLOUR</b>	<b>26 101 000</b>	a43 b18 c31	10	44x18x55h 0,043
<b>DISPLAY 1 COLOUR</b>	<b>26 101 000</b>	a48 b18 c31	78	57x50x103h 0,293
<b>DISPLAY MIX COLOUR</b>	<b>14 101 000</b>	a43 b18 c31	78	57x50x103h 0,293



**022**  
bianco/white  
blanc/weiß



**010**  
rosso/red  
rouge/rot



**419**  
giallo/yellow  
jaune/gelb



**402**  
lilyum/lilyum  
lilyum/lilyum



**404**  
cedro/cedar  
cèdre/zeder



**415**  
terra di Siena/terra di siena  
terra di siena/terra di siena

# T-Basket big

Superficie opaca  
Matt finished  
Surface opaque  
Matt-Oberfläche

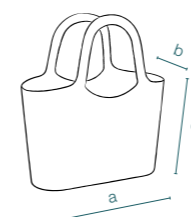
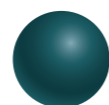

codice senza colore code without colour	Cm	dimensioni dimensions	pezzi pallet pcs pallet	m <sup>3</sup>
<b>BOX 1 COLOUR</b>	<b>26 102 000</b>	a48 b18 c51	6	44x18x55h 0,043
<b>DISPLAY 1 COLOUR</b>	<b>26 102 000</b>	a48 b18 c51	63	57x50x103h 0,293
<b>DISPLAY MIX COLOUR</b>	<b>14 102 000</b>	a48 b18 c51	63	57x50x103h 0,293



linea  
**FLORTEC**



norma



container



crisa



basso



# vaso Norma



**001**

terracotta/terracotta colour  
couleur terre/farbe terrakotta



**003**

nero/black  
noir/schwarz

A richiesta sono disponibili altri colori  
Further colours are available on demand  
D'autres couleurs sont disponibles sur demande  
Weiteren Farben sind auf Anforderung vorrätig



**010**

rosso/red  
rouge/rot



**013**

giallo/yellow  
jaune/gelb



**015**

azzurro/light blue  
azur/hellblau



**016**

arancio/orange  
orange/orange



**018**

ciclamino/cyclamen  
cyclamen/zyklamfarbe



**019**

lilla/lilac  
lilas/lila



**404**

cedro/cedar  
cèdre/zeder

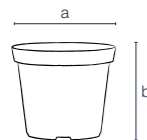

codice senza colore code without colour	Cm	colori colour	colori a richiesta colours on request	dimensioni dimensions	litri liters	pz/conf pcs/pack	Pcs Pit
03 300 008	8	001 003	010 013 015 016 018 019 404	a8 b6,8	0,2	2275	36400
03 300 010	10	001 003	010 013 015 016 018 019 404	a10 b7,7	0,38	1610	25760
03 300 011	11	001 003	010 013 015 016 018 019 404	a11 b8,8	0,53	1188	19008
03 300 012	12	001 003	010 013 015 016 018 019 404	a12 b10	0,72	915	14640
03 300 013	13	001 003	010 013 015 016 018 019 404	a13 b11	0,94	840	13440
03 300 014	14	001 003	010 013 015 016 018 019 404	a14 b12	1,25	671	10736
03 300 015	15	001 003	010 013 015 016 018 019 404	a15 b13	1,51	495	7920
03 300 016	16	001 003	010 013 015 016 018 019 404	a16 b12,2	1,79	360	5760
03 300 018	18	001 003	010 013 015 016 018 019 404	a18 b13,6	2,61	300	4800

## Flortec Special Packaging

Siamo in grado di fornirvi un'ampia gamma di **imballi speciali**.

We can provide to our customers a wide range of **special packaging**.

Nous pouvons vous fournir une large gamme d'**emballages spéciaux**.

Lieferung in **Sonderverpackungen** möglich.



# vaso Container



**001**  
 terracotta/terracotta colour  
 couleur terre/farbe terrakotta

**003**  
 nero/black  
 noir/schwarz

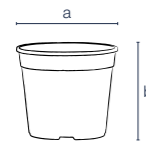

codice senza colore code without colour	Cm	colori colour	colori a richiesta colours on request	dimensioni dimensions	litri liters	pz/conf pcs/pack	Pcs Pit
03 301 015	15	001 003		a15 b13	1,63	423	6768
03 301 019	19	001 003	010 018 015 016 016 019 404	a19 b17,4	3,43	186	2976

# vaso Basso



**001**  
 terracotta/terracotta colour  
 couleur terre/farbe terrakotta

**003**  
 nero/black  
 noir/schwarz

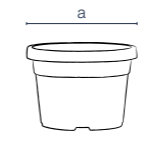

codice senza colore code without colour	Cm	colori colour	dimensioni dimensions	litri liters	pz/conf pcs/pack	Pcs Pit
03 303 017	17	001 003	a17 b12	1,74	192	3072

# vaso Crisa



**001**  
 terracotta/terracotta colour  
 couleur terre/farbe terrakotta

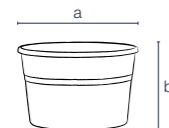

codice senza colore code without colour	Cm	colori colour	dimensioni dimensions	litri liters	pz/conf pcs/pack	Pcs Pit
03 304 022	22	001	a22 b15	3,31	140	2240

# Gabbia verde



**002**  
 verde/green  
 vert/grün

codice senza colore code without colour	Cm	colori colour	dimensioni dimensions	pz/conf pcs/pack	Pcs Pit
03 302 014	14	002	a14 b22	240	4800

# linea ESSENTIAL



avila



ribeira



zamora



standard one



leon



divio



corner

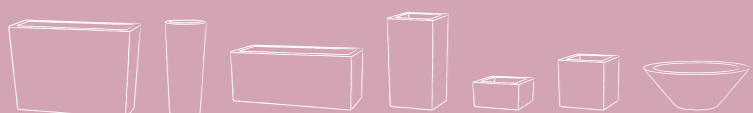

schio:  
cassa alta, cono, cassa, cubo alto,  
cubo basso, cubo, ciotola



veneto:  
quadro, cassa, jardinera, tondo



pasubio:  
alto, quadro, cassa



valentino



bassano







**Avila**

Superficie opaca  
Matt finished  
Surface opaque  
Matt-Oberfläche

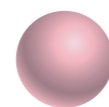

**043**  
bianco/white  
blanc/weiß



**204**  
grigio seta/silk grey  
grise soie/grauer Seide



**201**  
cappuccino/cappuccino  
cappuccino/cappuccino



**032**  
antracite/anthracite  
anthracite/anthrazitgrau



**233**  
toffee/toffee  
caramel/Toffee



**234**  
malva/mauve  
mauve/mauve



**230**  
cielo/sky blue  
ciel bleu/blauer Himmel



**202**  
lavanda/lavender  
lavande/lavendel



**068**  
fucsia/fuchsia  
fuchsia/fuchsiensfarbig



**208**  
menta/mint  
menthe/Minze



**232**  
kiwi/kiwi  
kiwi/Kiwi

colour on demand 030 050 011 049 210

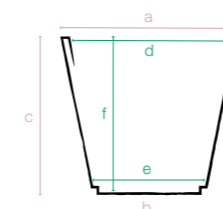

codice senza colore code without colour	Cm	dimensioni esterne external dimensions			dimensioni interne internal dimensions			litri liters	Confezione minima Minimum package	m <sup>3</sup>	pezzi pallet pcs pallet	m <sup>3</sup>
11 470 035	35	a:33	b:33	c:29	d:30	e:30	f:29	19	1 33x33x28h	0,03	66	80x120x115h 1,10
11 470 040	40	a:38	b:38	c:33	d:35	e:35	f:33	29	1 38x38x33h	0,04	54	80x120x115h 1,10
11 470 050	50	a:49	b:49	c:42	d:47	e:47	f:40	44	1 49x49x42h	0,10	32	80x120x220h 2,11





**043**  
bianco/white  
blanc/weiß



**204**  
grigio seta/silk grey  
grise soie/grauer Seide



**201**  
cappuccino/cappuccino  
cappuccino/cappuccino



**032**  
antracite/anthracite  
anthracite/anthrazitgrau



**039**  
bronzo/bronze  
bronze/bronze



**233**  
toffee/toffee  
caramel/Toffee



**234**  
malva/mauve  
mauve/mauve



**230**  
cielo/sky blue  
ciel bleu/blauer Himmel



**202**  
lavanda/lavender  
lavande/lavendel



**068**  
fucsia/fuchsia  
fuchsia/fuchsienfarbig



**232**  
kiwi/kiwi  
kiwi/Kiwi



**208**  
menta/mint  
menthe/Minze



**Sottovasi a richiesta  
saucers on demand  
soucoupe sur demand  
Unter-setzer auf Anfrage**  
pagina 169



5 misure  
5 sizes  
5 mesures  
5 Größen

colour on demand 030 050 211 049 210 203

**Ribeira**  
Superficie opaca  
Matt finished  
Surface opaque  
Matt-Oberfläche

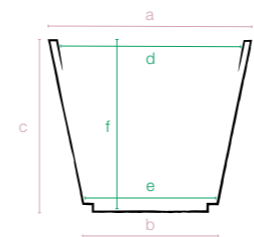

codice senza colore code without colour	Cm	dimensioni esterne external dimensions	dimensioni interne internal dimensions	litri liters	Confezione minima Minimum package	m <sup>3</sup>	pezzi pallet pcs pallet	m <sup>3</sup>
11 461 035	35	a33 b18,5 c29	d30 e18,5 f28	13	2	33x33x37h	0,04	63 80x120x115h 1,10
11 461 040	40	a38 b21,5 c35	d34,5 e21,5 f34	21	2	38x38x43h	0,06	114 80x120x230h 2,21
11 461 050	50	a49 b27,5 c43	d44,5 e27,5 f42	44	33	49x49x42h	0,10	64 100x120x230h 2,65
11 461 060	60	a57 b32 c49	d52 e32 f49	78	40	57x57x49h	0,15	28 80x120x220h 2,11
11 461 080	80	a77 b43 c65	d70 e43 f65	191	1	77x77x65h	0,38	10 80x80x220h 1,40



**043**  
bianco/white  
blanc/weiß



**204**  
grigio seta/silk grey  
grise soie/grauer Seide



**201**  
cappuccino/cappuccino  
cappuccino/cappuccino



**068**  
fucsia/fuchsia  
fuchsia/fuchsienfarbig



**232**  
kiwi/kiwi  
kiwi/Kiwi



**202**  
lavanda/lavender  
lavande/lavendel



**032**  
antracite/anthracite  
anthracite/anthrazitgrau

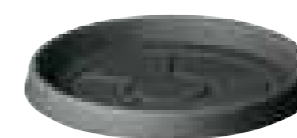

**Sottovaso**  
pagina 169

**Zamora**

Superficie opaca  
Matt finished  
Surface opaque  
Matt-Oberfläche

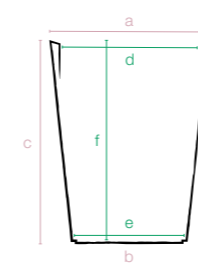
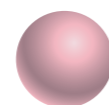

codice senza colore code without colour	Cm	dimensioni esterne external dimensions	dimensioni interne internal dimensions	litri liters	Confezione minima Minimum package	m <sup>3</sup>	pezzi pallet pcs pallet	m <sup>3</sup>
11 465 043	43	a33 b24 c42	d29 e24 f42	24	1 33x24x42h	0,03	98 80x120x225h	2,16
11 465 050	50	a39 b28,5 c50	d35 e28 f49	45	1 39x28,5x50h	0,30	60 80x120x215h	2,06
11 465 065	65	a49 b36 c66	d44 e35 f61	94	1 49x36x66h	0,10	21 80x120x210h	2,02

colour on demand 030 038 050 208 230 233 234 211 049 210 008



adatto anche per uso esterno  
also suitable for outdoor use  
également adapté pour une utilisation en extérieur  
Outdoor geeignet



**043**  
bianco/white  
blanc/weiß



**204**  
grigio seta/silk grey  
grise soie/grauer Seide



**201**  
cappuccino/cappuccino  
cappuccino/cappuccino



**030**  
anticato/light brown  
marron clair/hellbraun



**039**  
bronzo/bronze  
bronze/bronze



**050**  
rosso cardinale/cardinal red  
rouge cardinal/scharlachrot



**232**  
kiwi/kiwi  
kiwi/Kiwi



**202**  
lavanda/lavender  
lavande/lavendel



**032**  
antracite/anthracite  
anthracite/anthrazitgrau



**Sottovaso**  
pagina 169

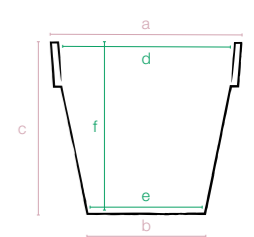

# Standard One

Superficie opaca  
Matt finished  
Surface opaque  
Matt-Oberfläche

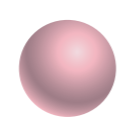

colour on demand 211 068 049 210 208 230 232 234 203

codice senza colore code without colour	Cm	dimensioni esterne external dimensions			dimensioni interne internal dimensions			litri liters	Confezione minima Minimum package	m <sup>3</sup>	pezzi pallet pcs pallet	m <sup>3</sup>
11 437 030	30	a30	b 18,5	c27	d26,5	e 18,5	f27	11	4 30x30x48h	0,04	88	80x120x115h 1,10
11 437 040	40	a40	b 25	c35	d36	e 25	f35	26	2 40x40x46h	0,07	48	80x120x112h 1,08
11 437 050	50	a50	b 31	c43	d44	e 31	f43	48	2 50x50x58h	0,14	64	100x120x226h 2,71
11 437 060	60	a60	b 37	c54	d53	e 37	f53	85	2 60x60x70h	0,25	22	80x120x215h 2,06
11 437 070	70	a70	b 43	c63	d61	e 43	f62	133	1 70x70x63h	0,30	9	80x80x215h 1,38
11 437 080	80	a80	b 49	c72	d70	e 49	f71	199	1 80x80x72h	0,46	8	80x80x220h 1,41
11 437 100	100	a100	b 61	c90	d88	e 61	f90	396	1 100x100x90h	0,90	6	100x120x225h 2,70
11 437 120	120	a120	b 74	c108	d105	e 74	f108	686	1 120x120x108h	1,29	4	120x120x215h 3,10
11 437 140	140	a140	b 86	c126	d123	e 86	f126	1079	1 140x140x207h	2,46	3	140x140x207h 4,05





Leon

Superficie opaca  
Matt finished  
Surface opaque  
Matt-Oberfläche

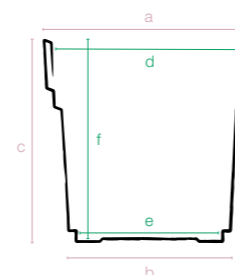
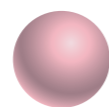

**043**  
bianco/white  
blanc/weiß



**201**  
cappuccino/cappuccino  
cappuccino/cappuccino



**032**  
antracite/anthracite  
anthracite/anthrazitgrau

colour on demand 030 050 211 202 068 203 232 208 230 233 234 204 049 210 038

codice senza colore code without colour	Cm	dimensioni esterne external dimensions			dimensioni interne internal dimensions			litri liters	Confezione minima Minimum package	m <sup>3</sup>	pezzi pallet pcs pallet	m <sup>3</sup>
11 471 035	35	a33	b33	c33	d29	e29	f33	9	1 33x33x33h	0,03	63	80x120x115h 1,10
11 471 040	40	a38	b38	c38	d35	e35	f38	15	1 38x38x38h	0,05	48	80x120x115h 1,10



## Divio indoor



**043**  
bianco/white  
blanc/weiß



**201**  
cappuccino/cappuccino  
cappuccino/cappuccino



**210**  
grafite/graphite  
graphite/graphit



**232**  
kiwi/kiwi  
kiwi/Kiwi

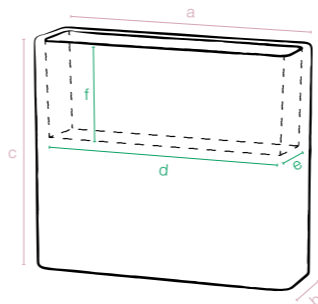

colour on demand 030 050 211 202 068 208 230 233 234 204 049 032 039 203

codice senza colore code without colour	Cm	dimensioni esterne external dimensions	dimensioni interne internal dimensions	litri liters	Confezione minima Minimum package	m <sup>3</sup>	pezzi pallet pcs pallet	m <sup>3</sup>
11 466 080	80	a:90 b:27 c:77	d:85 e:21 f:33	59	1 91x28x79h	0,2	8 80x120x201h	1,93

## Corner indoor



**043**  
bianco/white  
blanc/weiß



**201**  
cappuccino/cappuccino  
cappuccino/cappuccino



**210**  
grafite/graphite  
graphite/graphit



**232**  
kiwi/kiwi  
kiwi/Kiwi

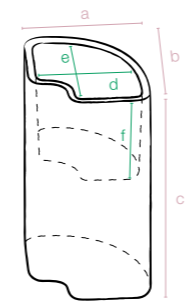

colour on demand 030 050 211 202 068 208 230 233 234 204 049 032 039 203

codice senza colore code without colour	Cm	dimensioni esterne external dimensions	dimensioni interne internal dimensions	litri liters	Confezione minima Minimum package	m <sup>3</sup>	pezzi pallet pcs pallet	m <sup>3</sup>
11 467 080	80	a:39 b:39 c:77	d:22 e:34 f:33	26	1 40x40x79h	0,1	15 80x120x213h	2,04

# Divio e Corner

Superficie opaca  
Matt finished  
Surface opaque  
Matt-Oberfläche



Divio e Corner si prestano molto bene per organizzare gli spazi  
 DIVIO and CORNER lend very well to organize spaces  
 Divio et Corner se prêtent très bien pour l'organisation des espaces  
 Divio und Corner sind ideal für die Teilung der Räume

Divio + Corner  
**componibili**  
**modular**  
**modulable**  
**zusammensetzbar**

Divio e Corner  
**indoor**  
**outdoor**

permettono diverse combinazioni  
 allow various combinations  
 ils permettent différentes combinaisons  
 Divio und Corner ermöglichen viele Zusammenstellungen

in base all'ambiente  
 depending on the environment  
 en fonction de l'environnement  
 nach dem Raum

e alla vostra fantasia  
 and to your imagination  
 et à votre imagination  
 und Ihrer Fantasie

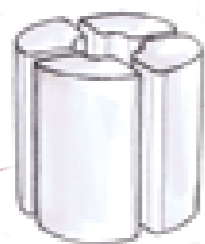
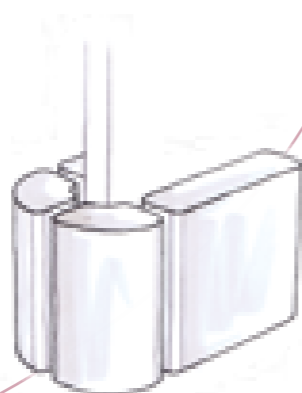
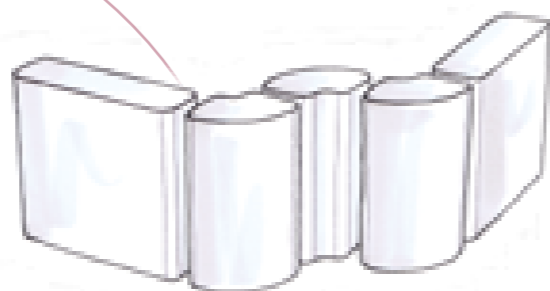
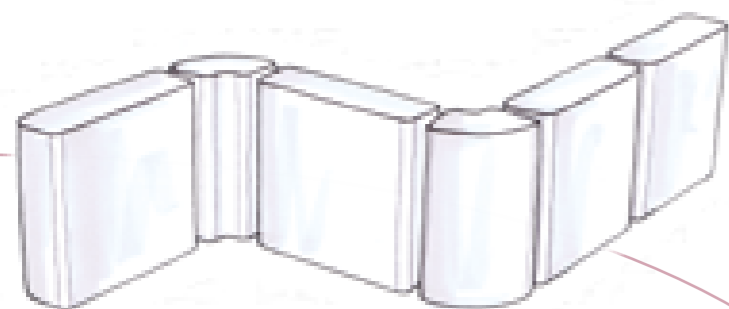

Divio

Corner

sabbia  
 sand  
 sable  
 Sand

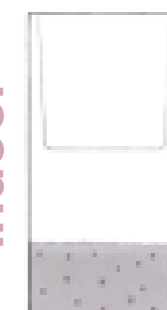

indoor

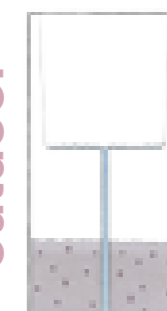

outdoor

foro di drenaggio per l'acqua in eccesso  
 drainage bore for water's excess  
 trou de drainage pour l'eau en excès  
 Entwässerungsloch

## Divio outdoor

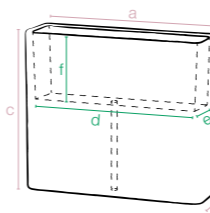

colour on demand 030 050 211 202 068 208 230 233 234 204 049 032 039 203

codice senza colore code without colour	Cm	dimensioni esterne external dimensions	dimensioni interne internal dimensions	litri liters	Confezione minima Minimum package	m <sup>3</sup>	pezzi pallet pcs pallet	m <sup>3</sup>
15 466 080	80	a:90 b:27 c:77	d:85 e:21 f:33	59	1 91x28x79h	0,2	8 80x120x201h	1,93

## Corner outdoor

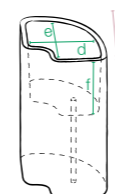

colour on demand 030 050 211 202 068 208 230 233 234 204 049 032 039 203

codice senza colore code without colour	Cm	dimensioni esterne external dimensions	dimensioni interne internal dimensions	litri liters	Confezione minima Minimum package	m <sup>3</sup>	pezzi pallet pcs pallet	m <sup>3</sup>
15 467 080	80	a:39 b:39 c:77	d:22 e:34 f:33	26	1 40x40x79h	0,1	15 80x120x213h	2,04

# Schio cassa alta



Superficie opaca  
Matt finished  
Surface opaque  
Matt-Oberfläche



# Schio cono

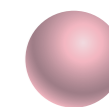

Superficie opaca  
Matt finished  
Surface opaque  
Matt-Oberfläche

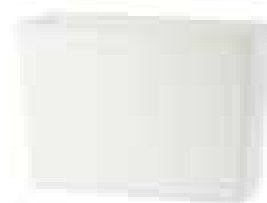

**043**

bianco/white  
blanc/weiß



**201**

cappuccino/cappuccino  
cappuccino/cappuccino



**032**

antracite/anthracite  
anthracite/anthrazitgrau



**050**

rosso cardinale/cardinal red  
rouge cardinal/scharlachrot



**043**

bianco/white  
blanc/weiß

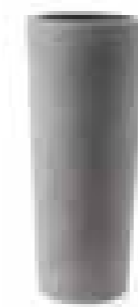

**201**

cappuccino/cappuccino  
cappuccino/cappuccino



**032**

antracite/anthracite  
anthracite/anthrazitgrau



**050**

rosso cardinale/cardinal red  
rouge cardinal/scharlachrot



**039**

bronzo/bronze  
bronze/bronze

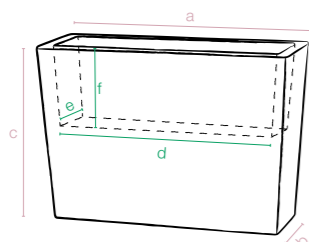

colour on demand 030 211 202 068 203 232 208 230 233 234 204 049 210 039

codice senza colore code without colour	Cm	dimensioni esterne external dimensions			dimensioni interne internal dimensions			litri liters	Confezione minima Minimum package	m <sup>3</sup>	pezzi pallet pcs pallet	m <sup>3</sup>
11 428 050	50	a50	b36	c70	d42	e28	f70	31	1 50x40x70h	0,14	12 80x120x222h	2,13
11 428 100	100	a100	b36	c70	d91	e28	f100	70	1 100x40x70h	0,28	6 80x120x222h	2,13

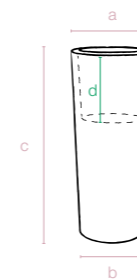

colour on demand 030 211 202 068 203 232 208 230 233 234 204 049 210

codice senza colore code without colour	Cm	dimensioni dimensions				litri liters	Confezione minima Minimum package	m <sup>3</sup>	pezzi pallet pcs pallet	m <sup>3</sup>	accessori accessories
11 424 070	70	a30	b23	c68	d20	8	1 30x30x68h	0,06	24 80x120x225h	2,16	[icon]
11 424 090	90	a40	b29,5	c90	d26	26	1 40x40x90h	0,14	12 80x120x195h	1,87	[icon]
11 424 110	110	a45	b34,5	c110	d28	35	1 45x45x110h	0,22	12 80x120x236h	2,27	[icon]
11 424 145	145	a55	b44,5	c145	d31	46	1 55x55x145h	0,43	4 100x120x160h	1,92	[icon]

Fix Ground  
Fix Wall  
pagina 198





# Schio

cassa



Superficie opaca  
Matt finished  
Surface opaque  
Matt-Oberfläche

# Schio

cubo alto

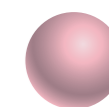

Superficie opaca  
Matt finished  
Surface opaque  
Matt-Oberfläche

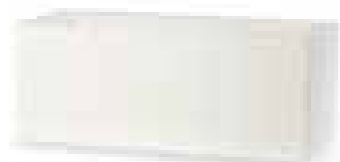

**043**

bianco/white  
blanc/weiß

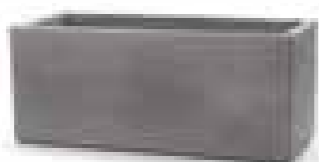

**201**

cappuccino/cappuccino  
cappuccino/cappuccino



**032**

antracite/anthracite  
anthracite/anthrazitgrau



**050**

rosso cardinale/cardinal red  
rouge cardinal/scharlachrot



**039**

bronzo/bronze  
bronze/bronze

colour on demand 030 211 202 088 203 232 208 230 233 234 204 049 210

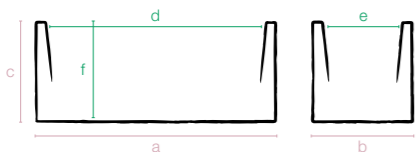

codice senza colore code without colour	Cm	dimensioni esterne external dimensions			dimensioni interne internal dimensions			litri liters	Confezione minima Minimum package	m³	pezzi pallet pcs pallet	m³
<b>11 427 060</b>	<b>60</b>	a60	b25	c25	d54	e20	f25	26	2 60x25x50h	0,07	24 80x120x115h	1,10
<b>11 427 080</b>	<b>80</b>	a80	b30	c30	d73	e24	f30	51	2 80x30x30h	0,07	28 80x120x222h	2,13
<b>11 427 100</b>	<b>100</b>	a100	b40	c40	d90	e30	f40	108	1 100x40x40h	0,16	10 80x120x210h	2,52
<b>11 427 120</b>	<b>120</b>	a115	b50	c50	d103	e38	f50	195	1 115x50x50h	0,28	8 100x120x220h	2,53



**043**

bianco/white  
blanc/weiß

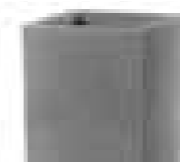

**201**

cappuccino/cappuccino  
cappuccino/cappuccino



**032**

antracite/anthracite  
anthracite/anthrazitgrau



**050**

rosso cardinale/cardinal red  
rouge cardinal/scharlachrot



**039**

bronzo/bronze  
bronze/bronze

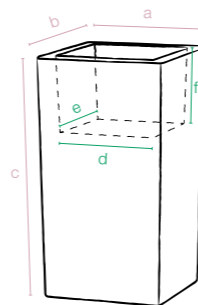

colour on demand 030 211 202 088 203 232 208 230 233 234 204 049 210

codice senza colore code without colour	Cm	dimensioni esterne external dimensions			dimensioni interne internal dimensions			litri liters	Confezione minima Minimum package	m³	pezzi pallet pcs pallet	m³	accessori accessories
<b>11 426 080</b>	<b>80</b>	a40	b40	c80	d30	e30	f20	31	1 40x40x80h	0,07	15 80x120x215h	1,10	

Fix Wall  
pagina 198



# Schio

## cubo basso



Superficie opaca  
Matt finished  
Surface opaque  
Matt-Oberfläche

# Schio

## cubo

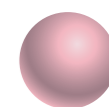

Superficie opaca  
Matt finished  
Surface opaque  
Matt-Oberfläche



**043**

bianco/white  
blanc/weiß

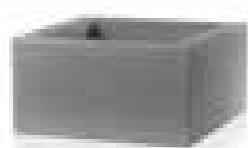

**201**

cappuccino/cappuccino  
cappuccino/cappuccino



**032**

antracite/anthracite  
anthracite/anthrazitgrau



**050**

rosso cardinale/cardinal red  
rouge cardinal/scharlachrot



**039**

bronzo/bronze  
bronze/bronze



**043**

bianco/white  
blanc/weiß

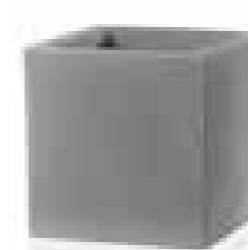

**201**

cappuccino/cappuccino  
cappuccino/cappuccino



**032**

antracite/anthracite  
anthracite/anthrazitgrau

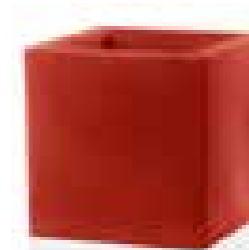

**050**

rosso cardinale/cardinal red  
rouge cardinal/scharlachrot



**039**

bronzo/bronze  
bronze/bronze

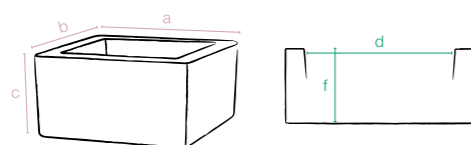
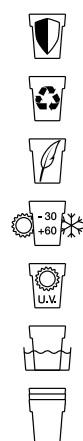

colour on demand 030 211 202 068 203 232 208 230 233 234 204 049 210

codice senza colore code without colour	Cm	dimensioni esterne external dimensions	dimensioni interne internal dimensions	litri liters	Confezione minima Minimum package	m <sup>3</sup>	pezzi pallet pcs pallet	m <sup>3</sup>
11 456 050	50	a50 b50 c20	d40 e40 f19	26	1 50x50x20h	0,05	14 80x120x115h	0,55

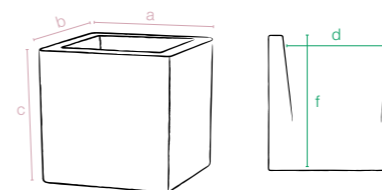
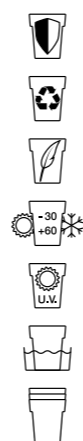

colour on demand 030 211 202 068 203 232 208 230 233 234 204 049 210

codice senza colore code without colour	Cm	dimensioni esterne external dimensions	dimensioni interne internal dimensions	litri liters	Confezione minima Minimum package	m <sup>3</sup>	pezzi pallet pcs pallet	m <sup>3</sup>
11 425 025	25	a25 b25 c25	d19,5 e19,5 f24	9	1 25x25x25h	0,01	48 80x120x115h	0,55
11 425 030	30	a30 b30 c30	d23,5 e23,5 f28	15	1 30x30x30h	0,02	24 80x120x115h	1,10
11 425 040	40	a40 b40 c40	d30 e30 f38	34	1 40x40x40h	0,06	12 80x120x92h	0,88
11 425 050	50	a50 b50 c50	d38 e38 f38	55	1 50x50x50h	0,12	8 100x120x112h	1,34
11 425 060	60	a58 b58 c58	d45 e45 f58	117	1 58x58x58h	0,19	6 80x120x200h	1,92

Schio family  
**componibile**  
 modular  
 modulaire  
 zusammensetzbar

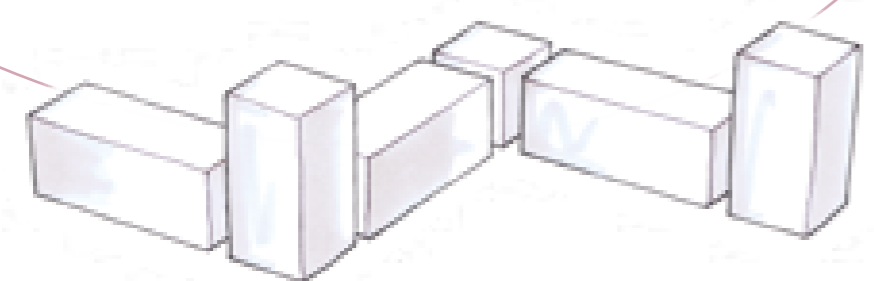
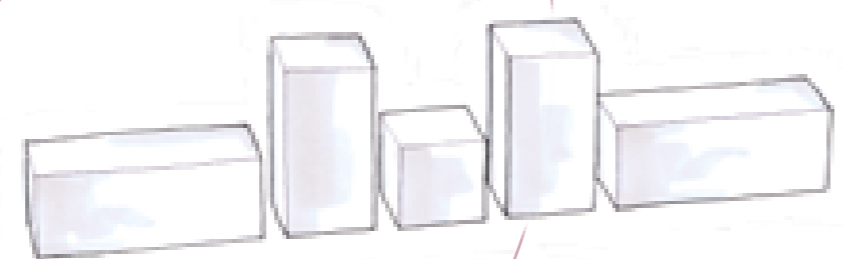
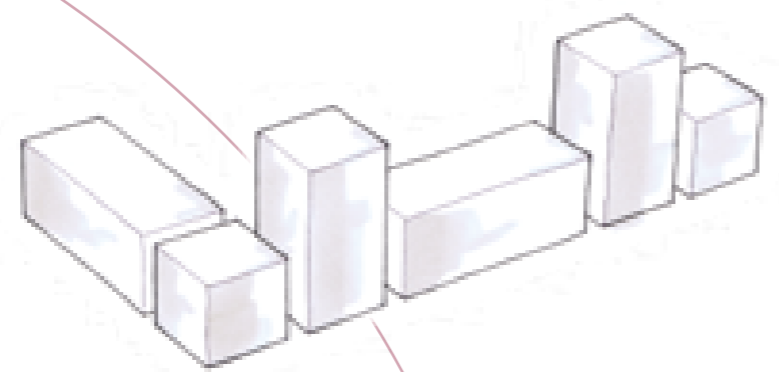
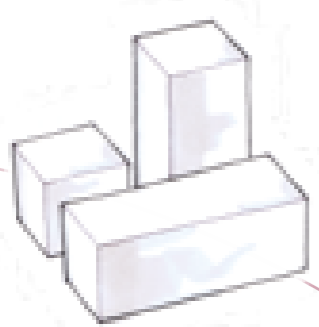

Schio cubo, Schio cubo alto e Schio cassa si prestano molto bene per organizzare gli spazi  
 Schio cubo, Schio cubo alto and Schio cassa lend very well to organize spaces  
 Schio Cubo, Cubo Alto et Cassa se prêtent très bien pour l'organisation des espaces  
 Schio Cubo, Schio Cubo Alto und Schio Cassa sind ideal für die Organization der Räume



**Schio**  
 ciotola

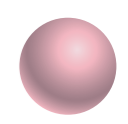

Superficie opaca  
 Matt finished  
 Surface opaque  
 Matt-Oberfläche

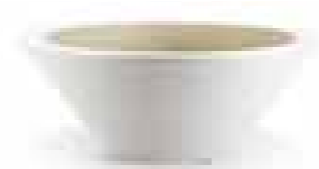

**043**  
 bianco/white  
 blanc/weiß



**201**  
 cappuccino/cappuccino  
 cappuccino/cappuccino



**032**  
 antracite/anthracite  
 anthracite/anthrazitgrau



**050**  
 rosso cardinale/cardinal red  
 rouge cardinal/scharlachrot



**039**  
 bronzo/bronze  
 bronze/bronze



**030**  
 anticato/light brown  
 marron clair/hellbraun

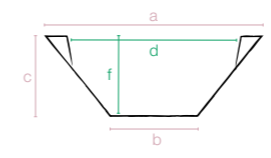
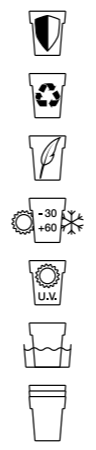

colour on demand 211 202 068 203 232 208 230 233 234 204 049 210

codice senza colore code without colour	Cm	dimensioni esterne external dimensions			dimensioni interne internal dimensions		litri liters	Confezione minima Minimum package	m <sup>3</sup>	pezzi pallet pcs pallet	m <sup>3</sup>
11 433 060	60	a60	b24,5	c22	d48	e21	22	2 60x60x30h	0,10	26	80x120x113h 1,08
11 433 080	80	a80	b32,5	c29	d64,5	e28	54	2 80x80x39h	0,25	10	80x80x113h 0,72
11 433 100	100	a100	b40	c37	d80	e36	106	1 100x100x37h	0,37	7	100x120x113h 1,36



## quadro Veneto

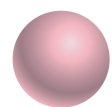

Superficie opaca  
Matt finished  
Surface opaque  
Matt-Oberfläche

## cassa Veneto

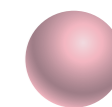

Superficie opaca  
Matt finished  
Surface opaque  
Matt-Oberfläche



**043**

bianco/white  
blanc/weiß



**201**

cappuccino/cappuccino  
cappuccino/cappuccino



**039**

bronzo/bronze  
bronze/bronze



**032**

antracite/anthracite  
anthracite/anthrazitgrau



**Sottovaso**  
pagina 169



**043**

bianco/white  
blanc/weiß



**201**

cappuccino/cappuccino  
cappuccino/cappuccino



**039**

bronzo/bronze  
bronze/bronze

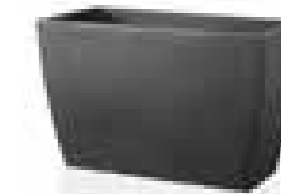

**032**

antracite/anthracite  
anthracite/anthrazitgrau

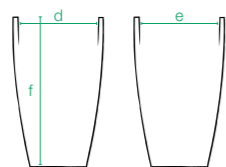
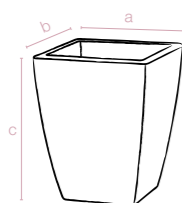

colour on demand 030 211 202 068 050 203 238 208 230 233 234 204 049 210

codice senza colore code without colour	Cm	dimensioni esterne external dimensions			dimensioni interne internal dimensions			litri liters		Confezione minima Minimum package	m <sup>3</sup>	pezzi pallet pcs pallet		m <sup>3</sup>
11 407 035	35	a:29	b:29	c:36	d:25	e:25	f:36	17	30	2 29x29x57h	0,04	32	80x120x115h	1,10
11 407 040	40	a:33	b:33	c:41	d:28,5	e:28,5	f:41	25	30	2 33x33x66h	0,07	48	80x120x230h	2,21
11 407 050	50	a:40	b:40	c:50	d:34	e:34	f:50	44	30	2 40x40x78h	0,12	42	80x120x228h	2,19
11 407 060	60	a:49	b:49	c:61	d:42	e:42	f:61	83	36	1 49x49x61h	0,14	20	100x120x230h	2,65
11 407 065	65	a:40	b:40	c:65	d:34	e:34	f:65	56	30	2 40x40x107h	0,17	30	80x120x238h	2,28

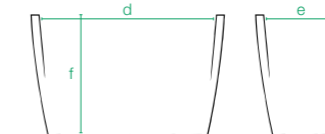
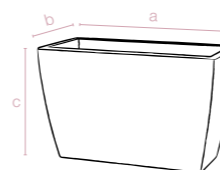

colour on demand 030 211 202 068 050 203 238 208 230 233 234 204 049 210

codice senza colore code without colour	Cm	dimensioni esterne external dimensions			dimensioni interne internal dimensions			litri liters	Confezione minima Minimum package	m <sup>3</sup>	pezzi pallet pcs pallet		m <sup>3</sup>
11 438 080	80	a:80	b:40	c:50	d:74	e:35	f:50	169	2 80x40x80h	0,25	18	80x120x228h	2,19



# jardinera Veneto



Superficie opaca  
Matt finished  
Surface opaque  
Matt-Oberfläche



# tondo Veneto

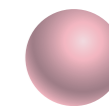

Superficie opaca  
Matt finished  
Surface opaque  
Matt-Oberfläche



**043**

bianco/white  
blanc/weiß

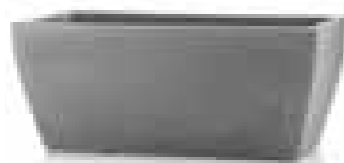

**201**

cappuccino/cappuccino  
cappuccino/cappuccino



**032**

antracite/anthracite  
anthracite/anthrazitgrau



**039**

bronzo/bronze  
bronze/bronze



**043**

bianco/white  
blanc/weiß



**201**

cappuccino/cappuccino  
cappuccino/cappuccino



**032**

antracite/anthracite  
anthracite/anthrazitgrau



**039**

bronzo/bronze  
bronze/bronze

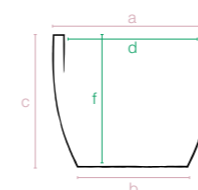
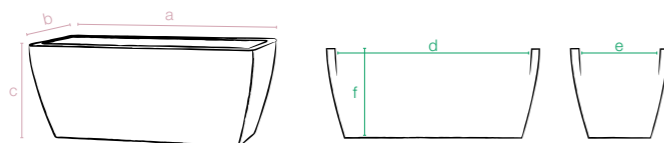

colour on demand 030 211 202 068 050 203 232 208 230 233 234 204 049 210

colour on demand 030 211 202 068 050 203 232 208 230 233 234 204 049 210

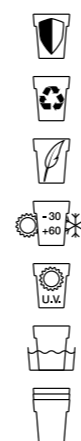

codice senza colore code without colour	Cm	dimensioni esterne external dimensions			dimensioni interne internal dimensions			litri liters	Confezione minima Minimum package	m <sup>3</sup>	pezzi pallet pcs pallet	m <sup>3</sup>
11 460 058	58	a:58	b:29	c:25	d:54	e:25	f:25	43	2 58x29x41h	0,06	52 80x120x230h	2,21
11 460 066	66	a:66	b:33	c:28	d:62	e:29	f:28	68	2 66x33x46h	0,10	33 80x120x230h	2,21
11 460 080	80	a:79	b:39	c:33	d:73	e:33	f:33	107	2 79x39x54h	0,16	27 80x120x230h	2,21

codice senza colore code without colour	Cm	dimensioni esterne external dimensions			dimensioni interne internal dimensions			litri liters	Confezione minima Minimum package	m <sup>3</sup>	pezzi pallet pcs pallet	m <sup>3</sup>
11 448 032	32	a:32	b:21	c:27	d:26	e:25	f:25	11	2 32x32x48h	0,04	64 80x120x232h	2,23
11 448 042	42	a:42	b:28	c:35	d:35	e:33	f:33	26	2 42x42x63h	0,11	36 80x120x222h	2,13
11 448 052	52	a:52	b:36	c:43	d:43	e:40	f:40	49	2 52x52x80h	0,21	15 80x120x227h	2,72
11 448 062	62	a:62	b:36	c:50	d:50	e:44	f:44	64	2 62x62x88h	0,33	10 80x120x207h	1,99



# Pasubio quadro



Superficie opaca  
Matt finished  
Surface opaque  
Matt-Oberfläche

# Pasubio cassa

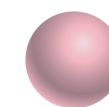

Superficie opaca  
Matt finished  
Surface opaque  
Matt-Oberfläche



**201**

cappuccino/cappuccino  
cappuccino/cappuccino



**032**

antracite/anthracite  
anthracite/anthrazitgrau



**201**

cappuccino/cappuccino  
cappuccino/cappuccino



**032**

antracite/anthracite  
anthracite/anthrazitgrau

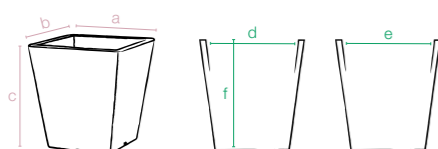
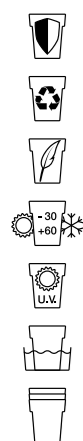

colour on demand 043 030 050 211 202 068 203 232 208 230 233 234 204 049 210 039

codice senza colore code without colour	Cm	dimensioni esterne external dimensions	dimensioni interne internal dimensions	litri liters	Confezione minima Minimum package	pezzi pallet pcs pallet	accessori accessories
11 463 040	40	a40 b40 c42	d34 e34 f42	40	2 40x40x71h	0,11 24 80x120x210h	2,02

Fix Ground  
Fix Wall  
pagina198

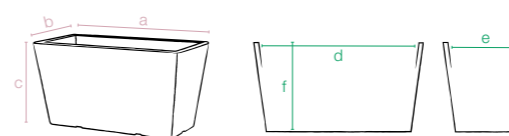
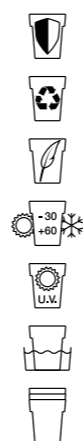

colour on demand 043 030 050 211 202 068 203 232 208 230 233 234 204 049 210 039

codice senza colore code without colour	Cm	dimensioni esterne external dimensions	dimensioni interne internal dimensions	litri liters	Confezione minima Minimum package	pezzi pallet pcs pallet	accessori accessories
11 464 080	80	a80 b40 c42	d74 e34 f42	66	2 80x40x71h	0,22 12 80x120x112h	1,08

Pasubio Alto,  
Quadro e Cassa  
**componibili**  
modular  
modulable  
zusammensetzbar



**Pasubio**  
alto



Superficie opaca  
Matt finished  
Surface opaque  
Matt-Oberfläche

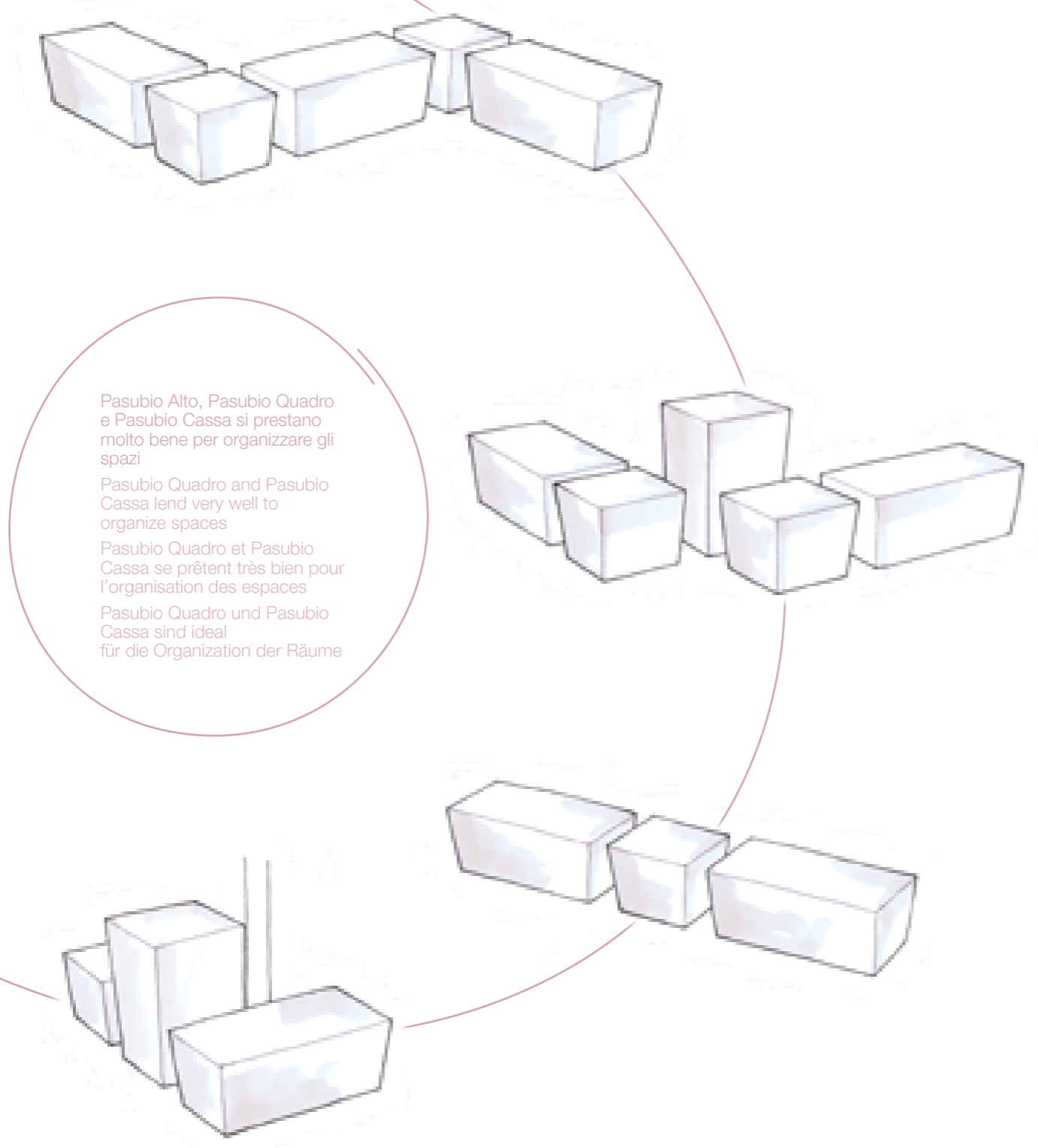

Pasubio Alto, Pasubio Quadro e Pasubio Cassa si prestano molto bene per organizzare gli spazi  
Pasubio Quadro and Pasubio Cassa lend very well to organize spaces  
Pasubio Quadro et Pasubio Cassa se prêtent très bien pour l'organisation des espaces  
Pasubio Quadro und Pasubio Cassa sind ideal für die Organization der Räume



**201**  
cappuccino/cappuccino  
cappuccino/cappuccino



**032**  
antracite/anthracite  
anthracite/anthrazitgrau

- 
- 
- 
- 
- 
- 
- 

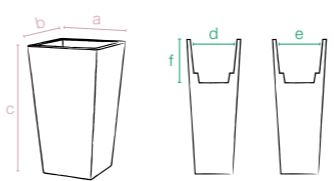

colour on demand 049 030 050 211 202 068 203 232 208 230 233 234 204 049 210 039

codice senza colore code without colour	Cm	dimensioni esterne external dimensions			dimensioni interne internal dimensions			litri liters	Confezione minima Minimum package	m <sup>2</sup>	pezzi pallet pcs pallet	m <sup>2</sup>	accessori accessories
<b>11 462 070</b>	<b>70</b>	a40	b40	c68	d34	e34	f25	31	1 40x40x70h	0,11	24 80x120x210h	2,02	
<b>11 462 100</b>	<b>100</b>	a40	b40	c100	d34	e34	f25	32	1 40x40x100h	0,16	12 80x120x212h	2,04	

Fix Ground  
Fix Wall  
pagina 198

# Valentino

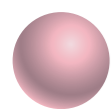

Superficie opaca  
Matt finished  
Surface opaque  
Matt-Oberfläche



# Bassano

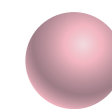

Superficie opaca  
Matt finished  
Surface opaque  
Matt-Oberfläche



**043**

bianco/white  
blanc/weiß



**201**

cappuccino/cappuccino  
cappuccino/cappuccino



**032**

antracite/anthracite  
anthracite/anthrazitgrau



**050**

rosso cardinale/cardinal red  
rouge cardinal/scharlachrot



**043**

bianco/white  
blanc/weiß



**201**

cappuccino/cappuccino  
cappuccino/cappuccino



**032**

antracite/anthracite  
anthracite/anthrazitgrau



**050**

rosso cardinale/cardinal red  
rouge cardinal/scharlachrot

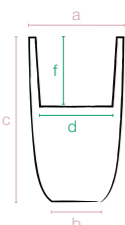
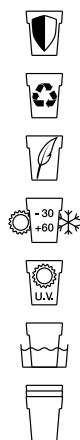

colour on demand 030 211 202 068 203 232 208 230 233 234 204 048 210 039

codice senza colore code without colour	Cm	dimensioni esterne external dimensions			dimensioni interne internal dimensions		litri liters	Confezione minima Minimum package	m <sup>3</sup>	pezzi pallet pcs pallet	m <sup>3</sup>	accessori accessories
11 432 050	50	a34	b21	c50	d26	f22	10	2 34x68x50h	0,11	16 80x120x112h	1,08	
11 432 070	70	a42	b25	c70	d32	f28	17	1 42x42x70h	0,12	18 80x120x226h	2,17	
11 432 090	90	a52	b30	c90	d40	f28	29	1 52x52x90h	0,24	8 100x120x195h	2,34	

Fix Ground  
Fix Wall  
pagina 198

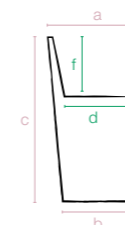

colour on demand 030 211 202 068 203 232 208 230 233 234 204 048 210 039

codice senza colore code without colour	Cm	dimensioni esterne external dimensions			dimensioni interne internal dimensions		litri liters	Confezione minima Minimum package	m <sup>3</sup>	pezzi pallet pcs pallet	m <sup>3</sup>	accessori accessories
11 423 060	60	a36	b29	c60	d27	f20	1	45x45x60h	0,12	24 80x120x202h	1,94	
11 423 100	100	a48	b35	c100	d35	f34	1	60x60x100h	0,36	6 100x120x165h	1,58	

Fix Ground  
Fix Wall  
pagina 198



## Essential Self Watering



### Riserva d'acqua

La riserva d'acqua permette di alimentare le vostre piante senza bisogno di irrigarle spesso. I fori di drenaggio per il "troppo pieno" permettono di scaricare eventuali eccessi di acqua così sarà la pianta stessa ad attingere alla riserva d'acqua quando ne avrà bisogno.

### Water reserve

The water reservoir allows to feed your plants without having to water it often. The drainage holes for the "overflow" allow you to download any excess water so the plant itself will be to draw on the reserve of water when it needs them. Some of the pots equipped with this system also have a coating membrane that, once removed, it allows excess water to leak from the pots.

### Avec reserve de l'eau

Le réservoir d'eau permet de nourrir vos plantes sans avoir à les arroser souvent. Les trous de drainage pour le «débordement» vous permettent de télécharger tout excès d'eau de sorte que sera elle-même à puiser dans la réserve d'eau quand il en aura besoin. Certains des pots équipés de ce système ont également une membrane d'enrobage qui, une fois enlevé, permet à l'eau en excès de sortir.

### Wasser reservoir

Das Wasser-Reservoir ermöglicht, Ihre Pflanzen zu versorgen, ohne ständig Wasser zuzuführen. Die Entwässerungslöcher lassen das Wasser überlaufen, damit die Pflanze das nach Bedarf schöpfen kann. Einige Pflanzgefäße mit Wasserspeicher besitzen eine Abdeckung-Membrane, die das Wasser, bei Wegnahme, überlaufen lässt.

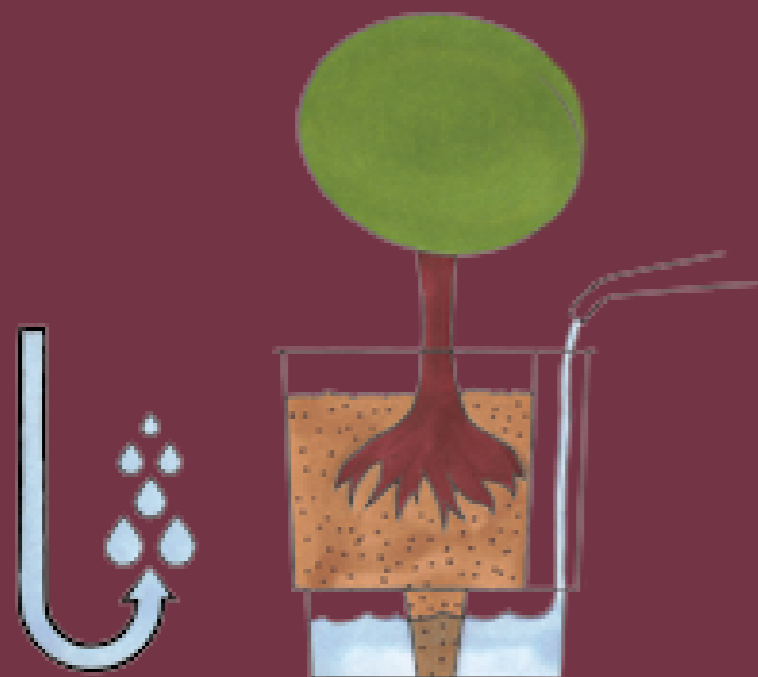

## Divio self watering

SELF WATERING



**043**  
bianco/white  
blanc/weiß



**201**  
cappuccino/cappuccino  
cappuccino/cappuccino



**210**  
grafite/graphite  
graphite/graphit



**232**  
kiwi/kiwi  
kiwi/Kiwi

colour on demand 030 050 211 202 068 208 230 233 234 204 049 032 039 203

codice senza colore code without colour	Cm	dimensioni esterne external dimensions	Confezione minima Minimum package	m <sup>3</sup>	pezzi pallet pcs pallet	m <sup>3</sup>
16 466 080	80	a 90 b 27 c 77	1 91x28x79h	0,2	8 80x120x201h	1,93

diffusione dell'acqua per osmosi  
water diffusion through osmosis's effect  
diffusion de l'eau par osmose  
Wasserdiffusion durch Osmose

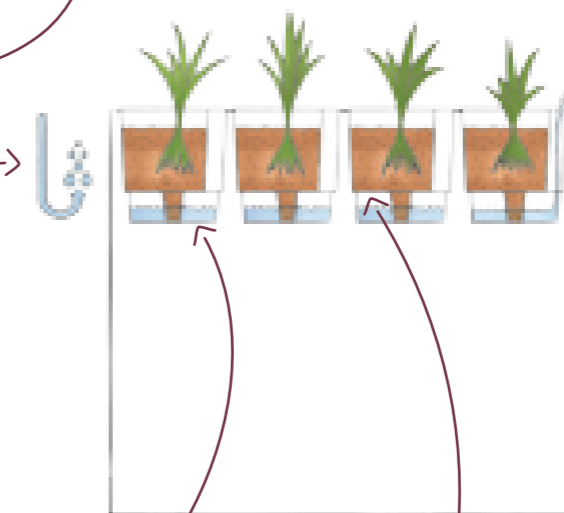

beccuccio per inserimento dell'acqua  
spout for water insertion  
bec pour l'introduction de l'eau  
Füllschacht zur Wasserversorgung

riserva d'acqua  
water reserve  
réserve d'eau  
Wasser-Reservoir

griglia di drenaggio  
drainage grid  
gril pour le drainage  
Bewässerungseinsatz

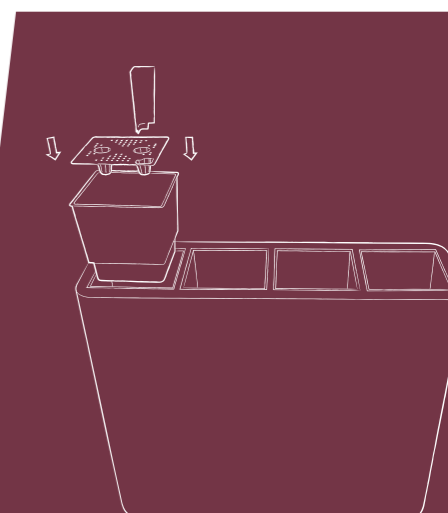

# Schio cubo self watering



**043** bianco/white  
blanc/weiß

**201** cappuccino/cappuccino  
cappuccino/cappuccino

**032** antracite/anthracite  
anthracite/anthrazitgrau

**050** rosso cardinale/cardinal red  
rouge cardinal/scharlachrot

**039** bronzo/bronze  
bronze/bronze

colour on demand 030 211 202 068 203 232 208 230 233 234 204 049 210

codice senza colore code without colour	Cm	dimensioni esterne external dimensions	Confezione minima Minimum package	m <sup>3</sup>	pezzi pallet pcs pallet	m <sup>3</sup>
16 425 030	30	a:30 b:30 c:28	1	30x30x30h	0,02	24 80x120x115h 1,10

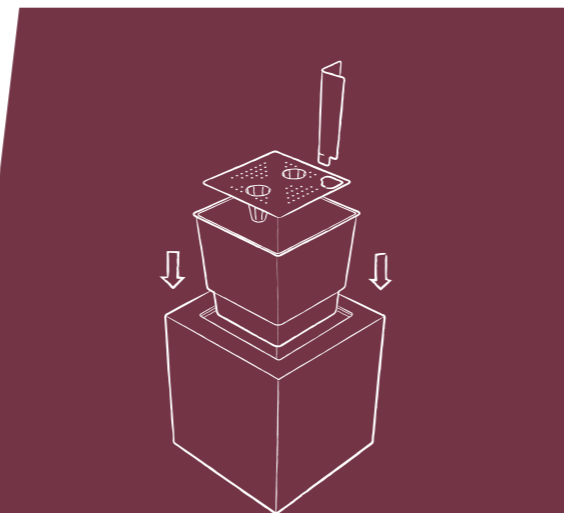
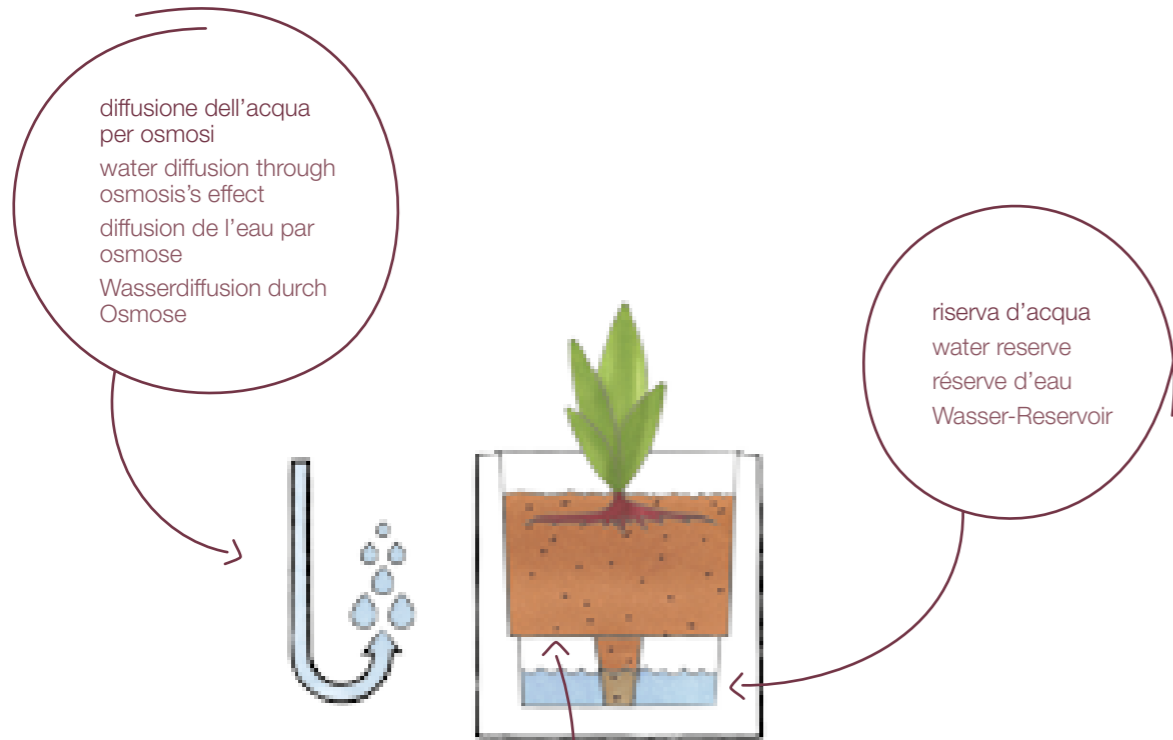

# Schio cassa self watering



**043** bianco/white  
blanc/weiß

**201** cappuccino/cappuccino  
cappuccino/cappuccino

**032** antracite/anthracite  
anthracite/anthrazitgrau

**050** rosso cardinale/cardinal red  
rouge cardinal/scharlachrot

**039** bronzo/bronze  
bronze/bronze

colour on demand 030 211 202 068 203 232 208 230 233 234 204 049 210

codice senza colore code without colour	Cm	dimensioni esterne external dimensions	Confezione minima Minimum package	m <sup>3</sup>	pezzi pallet pcs pallet	m <sup>3</sup>
16 427 080	80	a:80 b:30 c:30	2	80x30x30h	0,07	28 80x120x222h 2,13

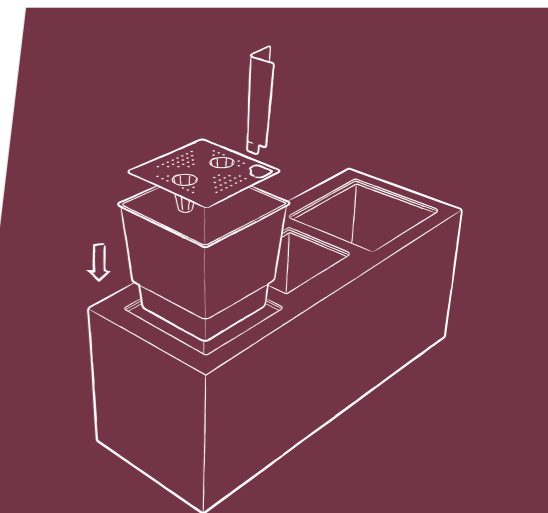
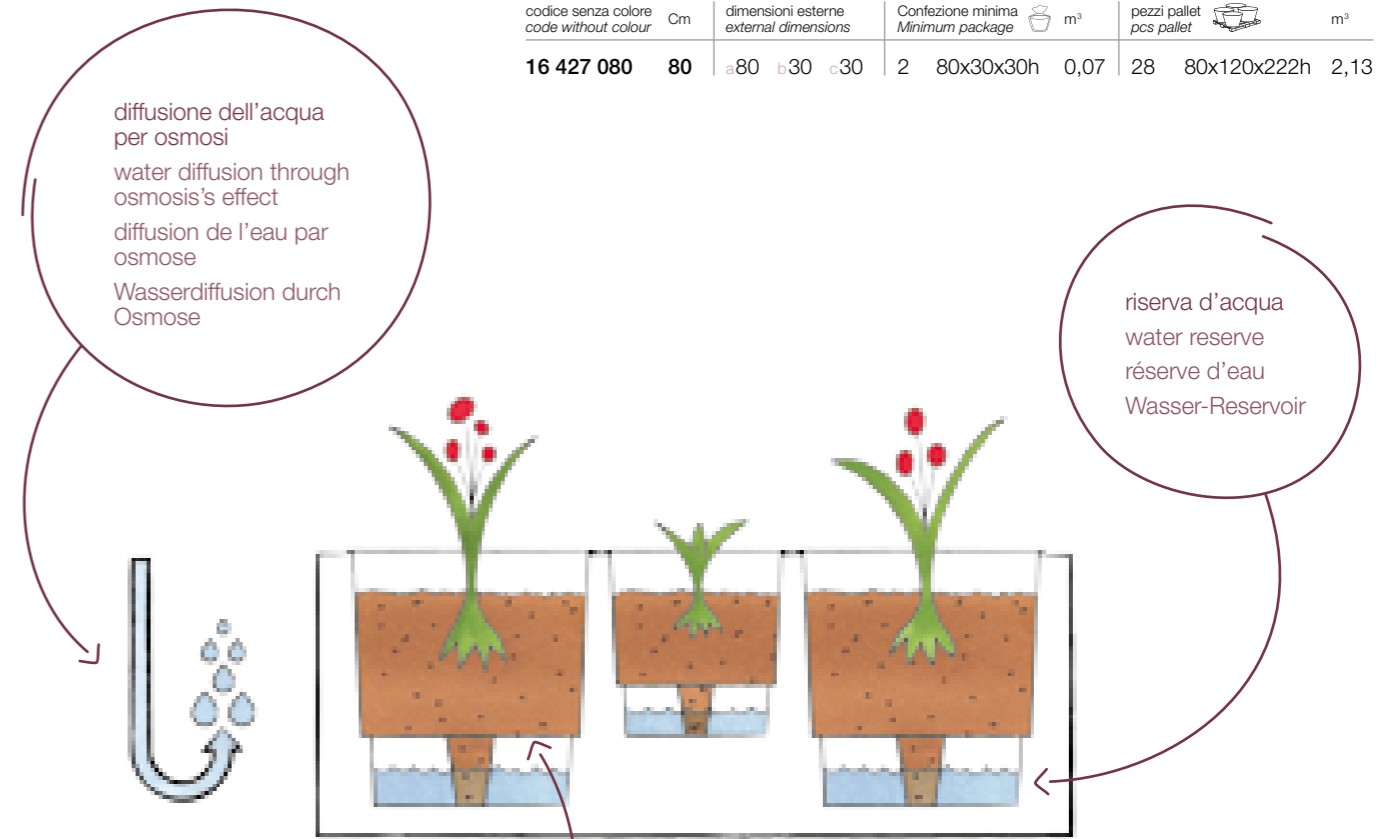

# linea CLASSIC

-  flora
-  cilindro vicenza
-  cassetta liscia, quadro liscio
-  africa
-  tulipano
-  vaso festonato
-  vaso doppio bordo
-  campana chiampo
-  cassetta leonardo
-  cassetta millerighe, quadro millerighe
-  cassetta molina, quadro molina
-  ciotola castello
-  conca classica
-  vaso muro righe, vaso muro liscio,  
sottovaso muro
-  sottovaso tondo
-  sottovaso quadro
-  sottocassetta





# Flora

Superficie opaca / Matt finished  
Surface opaque / Matt-Oberfläche



**030**

anticato/light brown  
marron clair/hellbraun



**201**

cappuccino/cappuccino  
cappuccino/cappuccino



**032**

antracite/anthracite  
anthracite/anthrazitgrau

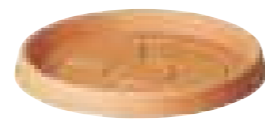

**Sottovaso**  
pagina 169

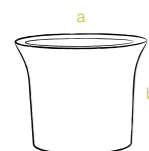
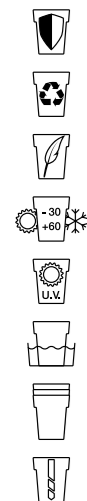

codice senza colore code without colour	Cm	dimensioni dimensions	litri liters		Confezione minima Minimum package	m <sup>3</sup>	pezzi pallet pcs pallet		m <sup>3</sup>
02 441 040	40	a40 b33	26	37	4 40x40x53h	0,08	72	80x120x115h	1,10
02 441 045	45	a45 b38	34	40	2 45x45x44h	0,08	125	100x120x224h	2,69
02 441 050	50	a50 b41	47	47	2 50x50x49h	0,12	64	100x120x220h	2,64

# cilindro Vicenza

Superficie opaca / Matt finished  
Surface opaque / Matt-Oberfläche



**030**

anticato/light brown  
marron clair/hellbraun



**201**

cappuccino/cappuccino  
cappuccino/cappuccino



**032**

antracite/anthracite  
anthracite/anthrazitgrau



**Sottovaso**  
pagina 169



codice senza colore code without colour	Cm	dimensioni dimensions	litri liters		Confezione minima Minimum package	m <sup>3</sup>	pezzi pallet pcs pallet		m <sup>3</sup>	accessori accessories
02 443 040	40	a40 b30	26	37	4 40x40x51h	0,08	66	80x120x115h	1,10	
02 443 045	45	a45 b34	40	40	2 45x45x41h	0,08	75	80x120x220h	2,11	
02 443 050	50	a50 b38	52	47	2 50x50x46h	0,11	66	100x120x225h	2,70	
02 443 060	60	a60 b45	94	54	2 60x60x55h	0,19	34	80x120x214h	2,05	
02 443 070	70	a70 b53	145	66	1 70x70x53h	0,26	15	80x80x224h	1,43	

Predisposto per ruote  
Prearranged for rollers  
Prévu pour roues  
Vorgesehen für Räder







## cassetta liscia



Superficie opaca / Matt finished  
Surface opaque / Matt-Oberfläche



**030**

anticato/light brown  
marron clair/hellbraun

**201**

cappuccino/cappuccino  
cappuccino/cappuccino

**032**

antracite/anthracite  
anthracite/anthrazitgrau

**Sottocassetta**  
pagina 169

Predisposto per ruote  
Prearranged for rollers  
Prévu pour roues  
Vorgesehen für Räder



codice senza colore code without colour	Cm	dimensioni dimensions	litri liters	Confezione minima Minimum package	m <sup>3</sup>	pezzi pallet pcs pallet	m <sup>3</sup>	accessori accessories
02 444 080	80	a 80 b 40 b 35	78	2 80x40x70h	0,22	18 80x120x224h	2,15	
02 444 100	100	a 100 b 46 b 41	133	2 100x46x82h	0,37	10 100x120x220h	2,64	

## quadro liscio



Superficie opaca / Matt finished  
Surface opaque / Matt-Oberfläche



**030**

anticato/light brown  
marron clair/hellbraun

**201**

cappuccino/cappuccino  
cappuccino/cappuccino

**032**

antracite/anthracite  
anthracite/anthrazitgrau

**Sottovaso**  
pagina 169

Predisposto per ruote  
Prearranged for rollers  
Prévu pour roues  
Vorgesehen für Räder

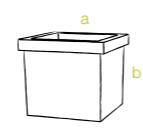
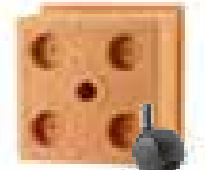

codice senza colore code without colour	Cm	dimensioni dimensions	litri liters	Confezione minima Minimum package	m <sup>3</sup>	pezzi pallet pcs pallet	m <sup>3</sup>	accessori accessories
02 445 040	40	a 40 b 40 c 35	35	2 40x40x70h	0,11	18 80x120x117h	1,12	
02 445 046	46	a 46 b 46 c 41	56	2 46x46x82h	0,17	20 100x120x219h	2,63	
02 445 055	55	a 55 b 55 c 48	95	2 55x55x48h	0,29	16 120x120x207h	2,98	

# Africa

Superficie opaca / Matt finished  
Surface opaque / Matt-Oberfläche



**030**

anticato/light brown  
marron clair/hellbraun



**201**

cappuccino/cappuccino  
cappuccino/cappuccino



**032**

antracite/anthracite  
anthracite/anthrazitgrau

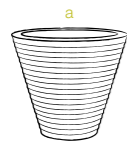

codice senza colore code without colour	Cm	dimensioni dimensions	Confezione minima Minimum package	m <sup>3</sup>	pezzi pallet pcs pallet	m <sup>3</sup>
02 418 080	80	a 80 b 69	1 80x80x70h	0,44	5 80x80x213h	1,36
02 418 105	105	a 105 b 90	1 105x105x90h	0,99	4 100x120x238h	2,86

# Tulipano

Superficie opaca / Matt finished  
Surface opaque / Matt-Oberfläche

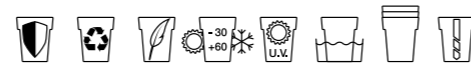

**030**

anticato/light brown  
marron clair/hellbraun



**201**

cappuccino/cappuccino  
cappuccino/cappuccino



**032**

antracite/anthracite  
anthracite/anthrazitgrau



codice senza colore code without colour	Cm	dimensioni dimensions	Confezione minima Minimum package	m <sup>3</sup>	pezzi pallet pcs pallet	m <sup>3</sup>	accessori accessories
02 419 110	110	a 62,5 b 110	1 65x65x110h	0,46	6 100x120x230h	2,76	

Fix Ground  
Fix Wall  
pagina 198

# vaso festonato

Superficie opaca / Matt finished  
Surface opaque / Matt-Oberfläche

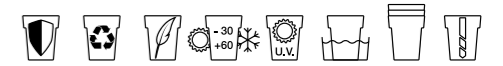

**030**

anticato/light brown  
marron clair/hellbraun



**201**

cappuccino/cappuccino  
cappuccino/cappuccino



**032**

antracite/anthracite  
anthracite/anthrazitgrau

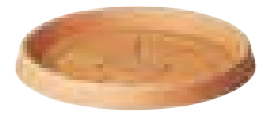

**Sottovaso**  
pagina 169



codice senza colore code without colour	Cm	dimensioni dimensions	litri liters	Confezione minima Minimum package	m <sup>3</sup>	pezzi pallet pcs pallet	m <sup>3</sup>
02 400 030	30	a 30 b 25 c 25	8	22 4 30x30x46h	0,04	96 80x120x113h	1,08
02 400 035	35	a 35 b 30 c 29,5	15	27 4 35x35x52h	0,06	66 80x120x112h	1,08
02 400 040	40	a 40 b 34 c 35	22	30 4 40x40x61h	0,09	54 80x120x112h	1,08
02 400 045	45	a 45 b 40 c 39	34	33 2 45x45x48h	0,09	88 80x120x220h	2,11
02 400 050	50	a 50 b 44 c 43	46	37 2 50x50x52h	0,13	80 100x120x222h	2,66
02 400 055	55	a 55 b 51 c 48	67	40 2 55x55x59h	0,17	40 80x120x224h	2,15
02 400 060	60	a 60 b 55 c 53	84	47 2 60x60x62h	0,22	30 80x120x226h	2,07
02 400 070	70	a 70 b 63 c 58	123	47 1 70x70x59h	0,28	14 80x80x224h	1,43
02 400 080	80	a 80 b 78 c 63	245	50 1 80x80x63h	0,40	13 80x80x217h	1,39

# vaso doppio bordo

Superficie opaca / Matt finished  
Surface opaque / Matt-Oberfläche

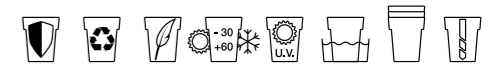

**030**

anticato/light brown  
marron clair/hellbraun



**201**

cappuccino/cappuccino  
cappuccino/cappuccino



**032**

antracite/anthracite  
anthracite/anthrazitgrau

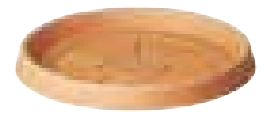

**Sottovaso**  
pagina 169



codice senza colore code without colour	Cm	dimensioni dimensions	litri liters	Confezione minima Minimum package	m <sup>3</sup>	pezzi pallet pcs pallet	m <sup>3</sup>
02 401 030	30	a 30 b 30 c 25	8	22 4 30x30x46h	0,04	96 80x120x115h	1,10
02 401 035	35	a 35 b 35 c 29	15	27 4 35x35x52h	0,06	60 80x120x113h	1,08
02 401 040	40	a 40 b 40 c 35	22	30 4 40x40x61h	0,09	48 80x120x112h	1,08
02 401 045	45	a 45 b 45 c 39	34	33 2 45x45x48h	0,09	80 80x120x220h	2,11
02 401 050	50	a 50 b 50 c 43	45	37 2 50x50x52h	0,13	76 100x120x228h	2,74
02 401 055	55	a 55 b 55 c 48	67	40 2 55x55x59h	0,17	36 80x120x220h	2,11
02 401 060	60	a 60 b 60 c 53	85	47 2 60x60x62h	0,22	30 80x120x219h	2,10
02 401 070	70	a 70 b 70 c 58	125	47 1 70x70x59h	0,28	14 80x80x219h	1,40
02 401 085	85	a 85 b 85 c 70	232	60 1 85x85x70h	0,50	11 100x120x215h	1,58

# campana Chiampo

Superficie opaca / Matt finished  
Surface opaque / Matt-Oberfläche



**030**  
anticato/light brown  
marron clair/hellbraun



**201**  
cappuccino/cappuccino  
cappuccino/cappuccino



**032**  
antracite/anthracite  
anthracite/anthrazitgrau



**Sottovaso**  
pagina 169

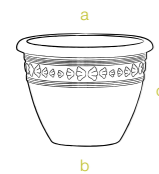

codice senza colore code without colour	Cm	dimensioni dimensions			litri liters		Confezione minima Minimum package	m <sup>3</sup>	pezzi pallet pcs pallet		m <sup>3</sup>
02 403 030	30	a30	b25,5	c23	8	22	4 30x30x51h	0,04	72	80x120x115h	1,10
02 403 040	40	a40	b33	c30	18	27	4 40x40x66h	0,10	42	80x120x115h	1,10
02 403 060	60	a60	b50	c47	65	40	4 60x60x67h	0,24	22	80x120x223h	2,23

# cassetta millerighe

Superficie opaca / Matt finished  
Surface opaque / Matt-Oberfläche

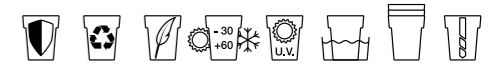

**030**  
anticato/light brown  
marron clair/hellbraun

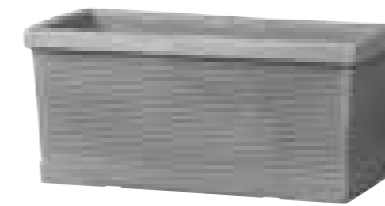

**201**  
cappuccino/cappuccino  
cappuccino/cappuccino



**032**  
antracite/anthracite  
anthracite/anthrazitgrau

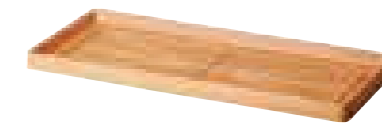

**Sottocassetta**  
pagina 169

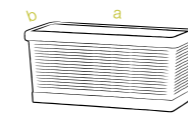

codice senza colore code without colour	Cm	dimensioni dimensions			litri liters		Confezione minima Minimum package	m <sup>3</sup>	pezzi pallet pcs pallet		m <sup>3</sup>
02 408 060	60	a59	b27	c27,6	32	60	2 59x27x56h	0,08	48	80x120x229h	2,20
02 408 080	80	a79	b34	c34	70	80	2 79x34x68h	0,18	18	80x120x221h	2,12
02 408 094	94	a94	b40	c38	130	94	2 94x40x76h	0,28	10	100x120x202h	2,42
02 408 100	100	a100	b44	c40	146	100	2 100x44x80h	0,35	10	100x120x228h	2,74

# cassetta Leonardo

Superficie opaca / Matt finished  
Surface opaque / Matt-Oberfläche



**030**  
anticato/light brown  
marron clair/hellbraun



**201**  
cappuccino/cappuccino  
cappuccino/cappuccino



**032**  
antracite/anthracite  
anthracite/anthrazitgrau

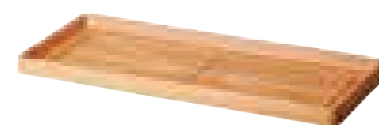

**Sottocassetta**  
pagina 169

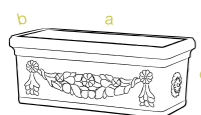

codice senza colore code without colour	Cm	dimensioni dimensions			litri liters		Confezione minima Minimum package	m <sup>3</sup>	pezzi pallet pcs pallet		m <sup>3</sup>
02 406 060	60	a58	b29	c27	29	60	2 58x29x54h	0,09	48	80x120x220h	2,11
02 406 080	80	a80	b34	c32	57	80	2 80x34x64h	0,17	18	80x120x202h	1,94
02 406 100	100	a100	b45	c40	120	100	2 100x45x80h	0,36	10	100x120x212h	2,54

# quadro millerighe

Superficie opaca / Matt finished  
Surface opaque / Matt-Oberfläche

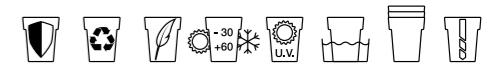

**030**  
anticato/light brown  
marron clair/hellbraun

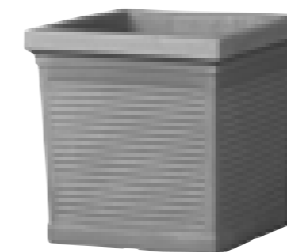

**201**  
cappuccino/cappuccino  
cappuccino/cappuccino



**032**  
antracite/anthracite  
anthracite/anthrazitgrau



**Sottovaso**  
pagina 169

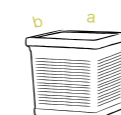

codice senza colore code without colour	Cm	dimensioni dimensions			litri liters		Confezione minima Minimum package	m <sup>3</sup>	pezzi pallet pcs pallet		m <sup>3</sup>
02 409 035	35	a35	b35	c34,6	28	36	2 35x35x70h	0,08	36	80x120x218h	2,09
02 409 040	40	a40	b40	c39,6	41	46	2 40x40x80h	0,12	30	80x120x207h	1,99
02 409 045	45	a45	b45	c40,1	59	46	2 45x45x81h	0,16	20	100x120x235h	2,82

# cassetta **Molina**

Superficie opaca / Matt finished  
Surface opaque / Matt-Oberfläche

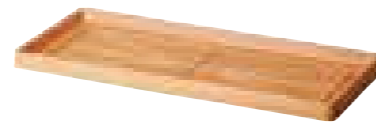

**030**

anticato/light brown  
marron clair/hellbraun

**032**

antracite/anthracite  
anthracite/anthrazitgrau

**Sottocassetta**  
pagina 169

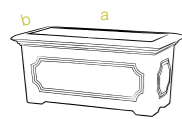

codice senza colore code without colour	Cm	dimensioni dimensions			litri liters		Confezione minima Minimum package	m <sup>3</sup>	pezzi pallet pcs pallet		m <sup>3</sup>	
<b>02 410 080</b>	<b>80</b>	a79	b38	c36	55	80	2	79x38x72h	0,21	18	80x120x225h	2,16
<b>02 410 100</b>	<b>100</b>	a99	b48	c45	121	100	2	99x48x90h	0,42	10	100x120x235h	2,82

# quadro **Molina**

Superficie opaca / Matt finished  
Surface opaque / Matt-Oberfläche

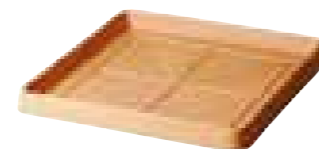

**030**

anticato/light brown  
marron clair/hellbraun

**032**

antracite/anthracite  
anthracite/anthrazitgrau

**Sottovaso**  
pagina 169



codice senza colore code without colour	Cm	dimensioni dimensions			litri liters		Confezione minima Minimum package	m <sup>3</sup>	pezzi pallet pcs pallet		m <sup>3</sup>	
<b>02 411 040</b>	<b>40</b>	a38	b38	c36	22	36	2	38x38x72h	0,10	36	80x120x227h	2,18
<b>02 411 050</b>	<b>50</b>	a48	b48	c45	49	46	2	48x48x90h	0,20	20	100x120x235h	2,82

# ciotola **Castello**

Superficie opaca / Matt finished  
Surface opaque / Matt-Oberfläche

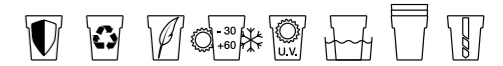

**030**

anticato/light brown  
marron clair/hellbraun

**201**

cappuccino/cappuccino  
cappuccino/cappuccino

**032**

antracite/anthracite  
anthracite/anthrazitgrau



codice senza colore code without colour	Cm	dimensioni dimensions		litri liters	Confezione minima Minimum package	m <sup>3</sup>	pezzi pallet pcs pallet		m <sup>3</sup>	
<b>02 405 050</b>	<b>50</b>	a50	b22	24	2	50x50x33h	0,08	32	80x120x115h	1,10
<b>02 405 060</b>	<b>60</b>	a60	b24,5	42	2	60x60x40h	0,14	12	80x120x115h	1,10
<b>02 405 080</b>	<b>80</b>	a80	b35	97	1	80x80x35h	0,22	11	80x80x210h	1,34

# conca **Classica**

Superficie opaca / Matt finished  
Surface opaque / Matt-Oberfläche



**030**

anticato/light brown  
marron clair/hellbraun

**201**

cappuccino/cappuccino  
cappuccino/cappuccino

**032**

antracite/anthracite  
anthracite/anthrazitgrau

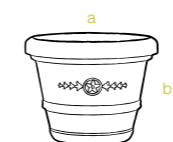

codice senza colore code without colour	Cm	dimensioni dimensions		litri liters	Confezione minima Minimum package	m <sup>3</sup>	pezzi pallet pcs pallet		m <sup>3</sup>	
<b>02 412 120</b>	<b>120</b>	a120	b94	541	1	120x120x95h	1,36	6	120x120x197h	2,84



## vaso Muro righe

Superficie opaca / Matt finished  
Surface opaque / Matt-Oberfläche



**030**

anticato/light brown  
marron clair/hellbraun



**201**

cappuccino/cappuccino  
cappuccino/cappuccino



**032**

antracite/anthracite  
anthracite/anthrazitgrau

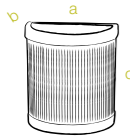

codice senza colore code without colour	Cm	dimensioni dimensions			Confezione minima Minimum package	m <sup>3</sup>	pezzi pallet pcs pallet	m <sup>3</sup>			
02 413 048	48	a48	b32	c52	53	1	48x32x52h	0,08	14	100x120x118h	1,42

## vaso Muro liscio

Superficie opaca / Matt finished  
Surface opaque / Matt-Oberfläche



**030**

anticato/light brown  
marron clair/hellbraun



**201**

cappuccino/cappuccino  
cappuccino/cappuccino



**032**

antracite/anthracite  
anthracite/anthrazitgrau

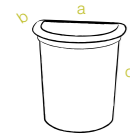

codice senza colore code without colour	Cm	dimensioni dimensions			Confezione minima Minimum package	m <sup>3</sup>	pezzi pallet pcs pallet	m <sup>3</sup>			
02 414 050	48	a48	b32	c52	53	1	48x32x52h	0,08	14	100x120x118h	1,42

## sottovaso Muro

Superficie opaca / Matt finished  
Surface opaque / Matt-Oberfläche



**030**

anticato/light brown  
marron clair/hellbraun



**201**

cappuccino/cappuccino  
cappuccino/cappuccino



**032**

antracite/anthracite  
anthracite/anthrazitgrau

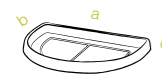

codice senza colore code without colour	Cm	dimensioni dimensions			Confezione minima Minimum package	m <sup>3</sup>	pezzi pallet pcs pallet	m <sup>3</sup>		
02 429 053	53	a53	b38	c4,5	1	53x38x5h	0,01	135	80x120x115h	1,10

## sottovaso Tondo

Superficie opaca / Matt finished  
Surface opaque / Matt-Oberfläche



**030**

anticato/light brown  
marron clair/hellbraun



**201**

cappuccino/cappuccino  
cappuccino/cappuccino



**032**

antracite/anthracite  
anthracite/anthrazitgrau

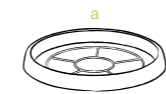

codice senza colore code without colour	Cm	dimensioni dimensions		Confezione minima Minimum package	m <sup>3</sup>	pezzi pallet pcs pallet	m <sup>3</sup>		
02 415 022	22	a22	b4	10	22x22x18h	0,01	600	80x120x115h	1,10
02 415 027	27	a27	b4	10	27x27x22h	0,01	550	80x120x115h	1,10
02 415 030	30	a30	b4	8	30x30x15h	0,01	320	80x120x115h	1,10
02 415 033	33	a33	b4	8	33x33x15h	0,02	336	80x120x115h	1,10
02 415 037	37	a37	b4	8	37x37x15h	0,02	288	80x120x115h	1,10
02 415 040	40	a40	b5	8	40x40x15h	0,03	288	80x120x115h	1,10
02 415 047	47	a47	b5	6	47x47x14h	0,03	180	80x120x115h	1,10
02 415 050	50	a50	b5	6	50x50x14h	0,03	180	80x120x115h	1,10
02 415 054	54	a54	b5	4	54x54x11h	0,03	120	80x120x115h	1,10
02 415 060	60	a60	b5	4	60x60x11h	0,04	92	80x120x115h	1,10
02 415 066	66	a66	b6	2	66x66x13h	0,05	46	80x120x115h	1,10

## sottovaso Quadro

Superficie opaca / Matt finished  
Surface opaque / Matt-Oberfläche



**030**

anticato/light brown  
marron clair/hellbraun

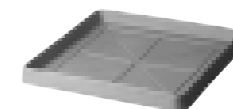

**201**

cappuccino/cappuccino  
cappuccino/cappuccino



**032**

antracite/anthracite  
anthracite/anthrazitgrau

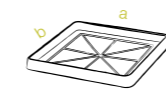

codice senza colore code without colour	Cm	dimensioni dimensions			Confezione minima Minimum package	m <sup>3</sup>	pezzi pallet pcs pallet	m <sup>3</sup>		
02 417 030	30	a30	b30	c5	2	30x30x7h	0,01	270	80x120x115h	1,10
02 417 036	36	a36	b36	c5	2	36x36x7h	0,01	270	80x120x115h	1,10
02 417 046	46	a46	b46	c5	2	46x46x7h	0,01	80	80x120x115h	1,10
02 417 056	56	a56	b56	c5	2	56x56x7h	0,02	80	80x120x115h	1,10

## Sottocassetta

Superficie opaca / Matt finished  
Surface opaque / Matt-Oberfläche



**030**

anticato/light brown  
marron clair/hellbraun



**201**

cappuccino/cappuccino  
cappuccino/cappuccino



**032**

antracite/anthracite  
anthracite/anthrazitgrau

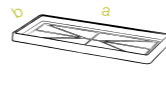

codice senza colore code without colour	Cm	dimensioni dimensions			Confezione minima Minimum package	m <sup>3</sup>	pezzi pallet pcs pallet	m <sup>3</sup>		
02 416 060	60	a60	b30	c5	2	60x31x7h	0,01	120	80x120x115h	1,10
02 416 080	80	a80	b36	c5	2	80x36x7h	0,02	80	80x120x115h	1,10
02 416 100	100	a100	b45	c5	2	100x45x7h	0,03	45	80x120x115h	1,10

# linea CITY



new york



venezia



roma



a-malo





## New York



Superficie opaca / Matt finished  
Surface opaque / Matt-Oberfläche

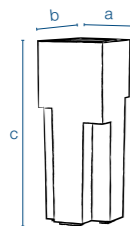
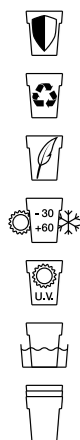

codice senza colore code without colour	Cm	dimensioni esterne external dimensions	Confezione minima Minimum package	m <sup>3</sup>	pezzi pallet pcs pallet	m <sup>3</sup>	accessori accessories
20 454 100	100	a39 b39 c100	1 40x40x102h	0,16	12 80x120x215h	2,06	

Fix Wall  
pagina 198

## Venezia



Superficie opaca / Matt finished  
Surface opaque / Matt-Oberfläche

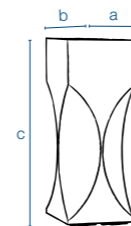
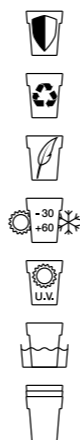

codice senza colore code without colour	Cm	dimensioni esterne external dimensions	Confezione minima Minimum package	m <sup>3</sup>	pezzi pallet pcs pallet	m <sup>3</sup>	accessori accessories
20 459 100	100	a39 b39 c100	1 40x40x102h	0,16	12 80x120x215h	2,06	

Fix Wall  
pagina 198



# Roma



Superficie opaca / Matt finished  
Surface opaque / Matt-Oberfläche

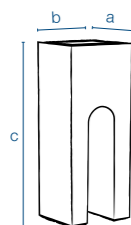

codice senza colore code without colour	Cm	dimensioni esterne external dimensions	Confezione minima Minimum package	m <sup>3</sup>	pezzi pallet pcs pallet	m <sup>3</sup>	accessori accessories
20 455 100	043 037	100	a39 b39 c100	1	40x40x102h	0,16	12 80x120x215h 2,06

Fix Wall  
pagina 198



# A-Malo



Superficie opaca / Matt finished  
Surface opaque / Matt-Oberfläche



Sistema di aggancio  
Coupling system  
Système d'accrochage  
Aufhäng System



Articolo composto da due pezzi per agevolare il trasporto  
The item is made up of two components to facilitate the transport  
Article composé de 2 pièces pour faciliter le transport  
Artikel besteht aus zwei teilen um der Transport zu erleichtern

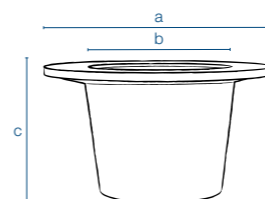
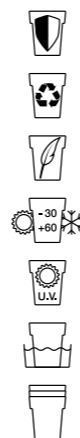

codice senza colore code without colour	Cm	dimensioni dimensions	Confezione minima Minimum package
20 458 150 vaso	043 037	150	b108 c110
20 452 150 anello	043 037	150	a150 c8
20 458 220 vaso	043 037	220	b158 c120
20 452 220 anello	043 037	220	a220 c10



# linea **LUCE**



standard one outdoor



spritz



africa outdoor



tulipano outdoor



valentino outdoor



pasubio alto outdoor



bassano outdoor



schio cassa alta outdoor



schio cubo alto outdoor



schio cono outdoor





# Standard one outdoor

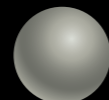

Superficie opaca / Matt finished  
Surface opaque / Matt-Oberfläche

# Spritz

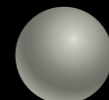

Superficie opaca / Matt finished  
Surface opaque / Matt-Oberfläche

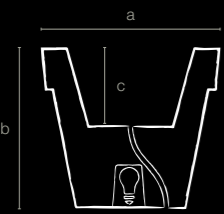

caratteristiche lampada: attacco E27, tensione max 220, potenza max 11 W, tipo risp. energ. standard  
lamp characteristics: electrical coupling E27, max voltage 220, max electrical power 11 W, standard energy saving type lamp  
caractéristiques de l'ampoule: culot E27, tension max 220, puissance max 11W, type économie d'énergie standard  
charakteristik der Lampe E27 Fassung, max. 220 Volt max. 11 W. Energiesparlampe Typ Standard

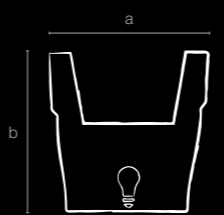

caratteristiche lampada: attacco E27, tensione max 220, potenza max 11 W, tipo risp. energ. standard  
lamp characteristics: electrical coupling E27, max voltage 220, max electrical power 11 W, standard energy saving type lamp  
caractéristiques de l'ampoule: culot E27, tension max 220, puissance max 11W, type économie d'énergie standard  
charakteristik der Lampe E27 Fassung, max. 220 Volt max. 11 W. Energiesparlampe Typ Standard

- 
- 
- 
- 
- 
- 
- 
- 

- 
- 
- 
- 
- 
- 
- 
- 

colour on demand 034 048 042 041

codice senza colore code without colour	Cm	dimensioni dimensions	litri liters	Confezione minima Minimum package	m <sup>3</sup>	pezzi pallet pcs pallet	m <sup>3</sup>	accessori accessories
13 437 070	033 70	a70 b63 c17	43	1 70x70x63h	0,30	4 80x80x220h	1,40	
13 437 080	033 80	a80 b72 c19	67	1 80x80x72h	0,40	4 80x80x220h	1,40	
13 437 100	033 100	a100 b90 c24	123	1 100x100x90h	0,90	3 100x120x220h	2,60	
13 437 120	033 120	a120 b108 c30	191	1 120x120x108h	1,50	2 120x120x220h	3,10	

Fix Wall  
pagina 198

colour on demand 034 048 042 041

codice senza colore code without colour	Cm	dimensioni dimensions	litri liters	Confezione minima Minimum package	m <sup>3</sup>	pezzi pallet pcs pallet	m <sup>3</sup>	accessori accessories
05 446 038	033 38	a38 b35	43	1 40x40x63h	0,06	18 80x120x130h	1,20	

Fix Wall  
pagina 198



## Africa outdoor

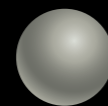

Superficie opaca / Matt finished  
Surface opaque / Matt-Oberfläche

caratteristiche lampada: attacco E27, tensione max 220, potenza max 11 W, tipo risp. energ. standard

lamp characteristics: electrical coupling E27, max voltage 220, max electrical power 11 W, standard energy saving type lamp

caractéristiques de l'ampoule: culot E27, tension max 220, puissance max 11W, type économie d'énergie standard

charakteristik der Lampe E27 Fassung, max. 220 Volt max. 11 W. Energiesparlampe Typ Standard

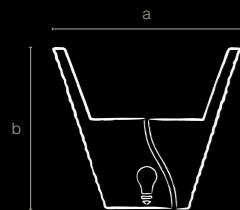

colour on demand 034 048 042 041

codice senza colore code without colour	Cm	dimensioni dimensions		litri liters	Confezione minima Minimum package	m <sup>3</sup>	pezzi pallet pcs pallet	m <sup>3</sup>
<b>13 418 080</b> <span style="background-color: #cccccc; padding: 0 2px;">033</span> <b>80</b>		a:80	b:69	82	1 80x80x70h	0,40	5 80x80x216h	1,40
<b>13 418 105</b> <span style="background-color: #cccccc; padding: 0 2px;">033</span> <b>105</b>		a:105	b:90	161	1 80x80x72h	1,00	4 100x120x238h	2,90



LINEA

## Tulipano outdoor



Superficie opaca / Matt finished  
Surface opaque / Matt-Oberfläche

caratteristiche lampada: attacco E27, tensione max 220, potenza max 11 W, tipo risp. energ. standard

lamp characteristics: electrical coupling E27, max voltage 220, max electrical power 11 W, standard energy saving type lamp

caractéristiques de l'ampoule: culot E27, tension max 220, puissance max 11W, type économie d'énergie standard

charakteristik der Lampe E27 Fassung, max. 220 Volt max. 11 W. Energiesparlampe Typ Standard

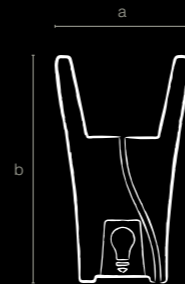

colour on demand 034 048 042 041

codice senza colore code without colour	Cm	dimensioni dimensions		litri liters	Confezione minima Minimum package	m <sup>3</sup>	pezzi pallet pcs pallet	m <sup>3</sup>	accessori accessories
<b>13 419 110</b> <span style="background-color: #cccccc; padding: 0 2px;">033</span> <b>110</b>		a:65	b:110	65	1 65x65x110h	0,50	6 100x120x230h	0,76	



Fix Ground  
Fix Wall  
pagina 198



## Valentino outdoor

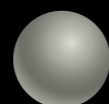

Superficie opaca / Matt finished  
Surface opaque / Matt-Oberfläche

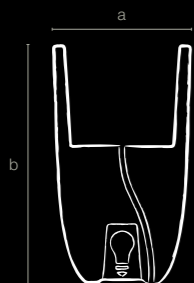

caratteristiche lampada: attacco E27, tensione max 220, potenza max 11 W, tipo risp. energ. standard

lamp characteristics: electrical coupling E27, max voltage 220, max electrical power 11 W, standard energy saving type lamp

caractéristiques de l'ampoule: culot E27, tension max 220, puissance max 11W, type économie d'énergie standard

charakteristik der Lampe E27 Fassung, max. 220 Volt max. 11 W. Energiesparlampe Typ Standard

colour on demand 034 048 042 041

codice senza colore code without colour	Cm	dimensioni dimensions	litri liters	Confezione minima Minimum package	m <sup>3</sup>	pezzi pallet pcs pallet	m <sup>3</sup>	accessori accessories
<b>13 432 050</b> <span style="background-color: #cccccc; padding: 0 2px;">033</span>	50	a34 b50	10	1 34x34x50h	0,06	16 80x120x112h	1,10	
<b>13 432 070</b> <span style="background-color: #cccccc; padding: 0 2px;">033</span>	70	a42 b70	17	1 42x42x70h	0,10	18 80x120x226h	2,20	
<b>13 432 090</b> <span style="background-color: #cccccc; padding: 0 2px;">033</span>	90	a52 b90	29	1 52x52x90h	0,20	8 100x120x195h	2,30	

Fix Ground  
Fix Wall  
pagina 198



## Pasubio alto outdoor

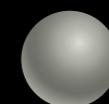

Superficie opaca / Matt finished  
Surface opaque / Matt-Oberfläche

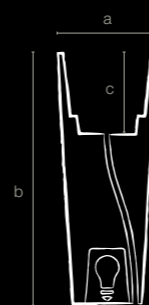

caratteristiche lampada: attacco E27, tensione max 220, potenza max 11 W, tipo risp. energ. standard

lamp characteristics: electrical coupling E27, max voltage 220, max electrical power 11 W, standard energy saving type lamp

caractéristiques de l'ampoule: culot E27, tension max 220, puissance max 11W, type économie d'énergie standard

charakteristik der Lampe E27 Fassung, max. 220 Volt max. 11 W. Energiesparlampe Typ Standard

colour on demand 034 048 042 041

codice senza colore code without colour	Cm	dimensioni dimensions	litri liters	Confezione minima Minimum package	m <sup>3</sup>	pezzi pallet pcs pallet	m <sup>3</sup>	accessori accessories
<b>13 462 070</b> <span style="background-color: #cccccc; padding: 0 2px;">033</span>	70	a40 b68 a25	31	1 40x40x70h	0,10	24 80x120x210h	2,00	
<b>13 462 100</b> <span style="background-color: #cccccc; padding: 0 2px;">033</span>	100	a40 b100 a25	32	1 40x40x100h	0,10	12 80x120x212h	2,00	

Fix Ground  
Fix Wall  
pagina 198







## Bassano outdoor

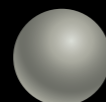

Superficie opaca / Matt finished  
Surface opaque / Matt-Oberfläche

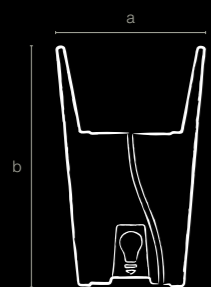

caratteristiche lampada: attacco E27, tensione max 220, potenza max 11 W, tipo risp. energ. standard

lamp characteristics: electrical coupling E27, max voltage 220, max electrical power 11 W, standard energy saving type lamp

caractéristiques de l'ampoule: culot E27, tension max 220, puissance max 11W, type économie d'énergie standard

charakteristik der Lampe E27 Fassung, max. 220 Volt max. 11 W. Energiesparlampe Typ Standard

colour on demand 034 048 042 041

codice senza colore code without colour	Cm	dimensioni dimensions	litri liters	Confezione minima Minimum package	m <sup>3</sup>	pezzi pallet pcs pallet	m <sup>3</sup>	accessori accessories
13 423 060	033 60	a45 b60	17	1 45x45x60h	0,10	12 80x120x200h	2,40	
13 423 100	033 100	a60 b100	48	1 60x60x100h	0,30	4 80x120x220h	2,10	

Fix Ground  
Fix Wall  
pagina 198



LINEA  
LUCE

## Schio cassa alta outdoor

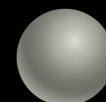

Superficie opaca / Matt finished  
Surface opaque / Matt-Oberfläche

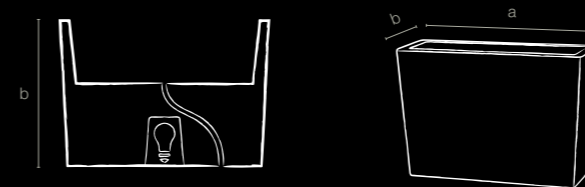

caratteristiche lampada: attacco E27, tensione max 220, potenza max 11 W, tipo risp. energ. standard

lamp characteristics: electrical coupling E27, max voltage 220, max electrical power 11 W, standard energy saving type lamp

caractéristiques de l'ampoule: culot E27, tension max 220, puissance max 11W, type économie d'énergie standard

charakteristik der Lampe E27 Fassung, max. 220 Volt max. 11 W. Energiesparlampe Typ Standard

colour on demand 034 048 042 041

codice senza colore code without colour	Cm	dimensioni dimensions	litri liters	Confezione minima Minimum package	m <sup>3</sup>	pezzi pallet pcs pallet	m <sup>3</sup>
13 428 050	033 50	a50 b36 c70	31	1 50x36x70h	0,10	12 80x120x222h	2,10
13 428 100	033 100	a100 b36 c70	70	1 100x36x70h	0,20	6 80x120x222h	2,10



LINEA

## Schio cubo alto outdoor



Superficie opaca / Matt finished  
Surface opaque / Matt-Oberfläche

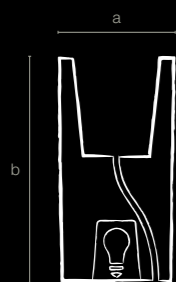

caratteristiche lampada: attacco E27, tensione max 220, potenza max 11 W, tipo risp. energ. standard  
lamp characteristics: electrical coupling E27, max voltage 220, max electrical power 11 W, standard energy saving type lamp  
caractéristiques de l'ampoule: culot E27, tension max 220, puissance max 11W, type économie d'énergie standard  
charakteristik der Lampe E27 Fassung, max. 220 Volt max. 11 W. Energiesparlampe Typ Standard

- 
- 
- 
- 
- 
- 

colour on demand 034 048 042 041

codice senza colore code without colour	Cm	dimensioni dimensions	litri liters	Confezione minima Minimum package	m <sup>3</sup>	pezzi pallet pcs pallet	m <sup>3</sup>	accessori accessories
13 426 080	033	80	a40 b80	31	1	40x40x80h	0,10	15 80x120x212h 2,00

Fix Wall  
pagina 198

## Schio cono outdoor

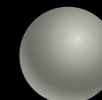

Superficie opaca / Matt finished  
Surface opaque / Matt-Oberfläche

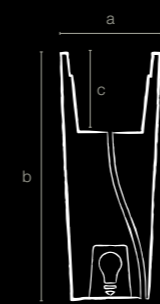

caratteristiche lampada: attacco E27, tensione max 220, potenza max 11 W, tipo risp. energ. standard  
lamp characteristics: electrical coupling E27, max voltage 220, max electrical power 11 W, standard energy saving type lamp  
caractéristiques de l'ampoule: culot E27, tension max 220, puissance max 11W, type économie d'énergie standard  
charakteristik der Lampe E27 Fassung, max. 220 Volt max. 11 W. Energiesparlampe Typ Standard

- 
- 
- 
- 
- 
- 

colour on demand 034 048 042 041

codice senza colore code without colour	Cm	dimensioni dimensions	litri liters	Confezione minima Minimum package	m <sup>3</sup>	pezzi pallet pcs pallet	m <sup>3</sup>	accessori accessories
13 424 070	033	70	a30 b68 b20	8	1	30x30x68h	0,06	24 80x120x225h 2,10
13 424 090	033	90	a40 b90 b26	26	1	40x40x90h	0,10	12 80x120x195h 1,80
13 424 110	033	110	a45 b110 b28	35	1	45x45x110h	0,20	12 80x120x236h 2,20
13 424 145	033	145	a55 b145 b31	46	1	55x55x145h	0,40	4 100x120x160h 1,90

Fix Ground  
Fix Wall  
pagina 198



# A-malo luce outdoor

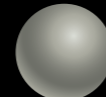

Superficie opaca / Matt finished  
Surface opaque / Matt-Oberfläche

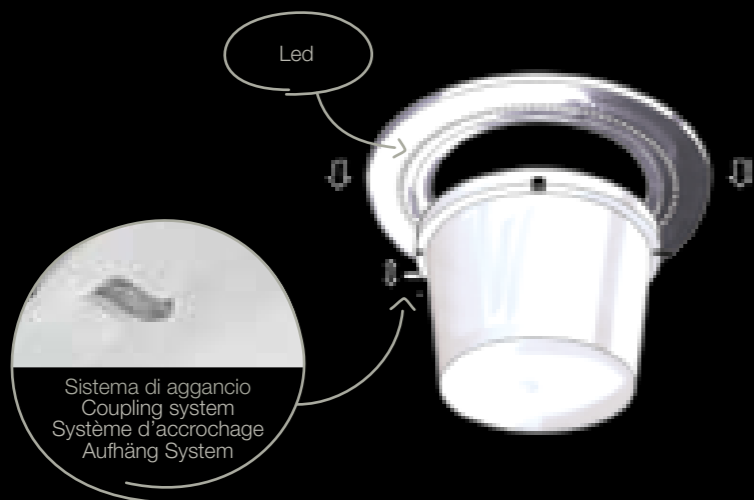
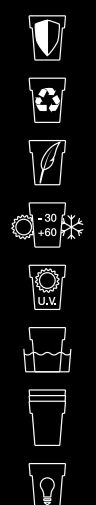





Led

Sistema di aggancio  
Coupling system  
Système d'accrochage  
Aufhäng System

l'anello del vaso a-malo è dotato di una striscia led  
the ring of pot a-malo is equipped with LED strip  
l'anneau du pot A-malo est équipé de bande de LED  
Der Ring vom Topf A-Malo ist mit LED-Streifen zur Beleuchtung ausgestattet



a

codice senza colore code without colour	Cm	dimensioni dimensions	Confezione minima Minimum package
13 452 150 anello luce  	150	a 150	1 150x150x8h 0,18
13 452 220 anello luce  	220	a 220	1 158x158x120h 2,99

**Luce inclusa**  
White cold lamp  
Ampoule à blanche  
Lampe weiss



Per tutti gli articoli della linea Luce è possibile acquistare come supplemento la lampadina LED, disponibile in due versioni:  
For all items of the collection Luce it is possible to buy an additional LED lamp, of which two options are available:  
Pour tous les articles de la ligne Luce il est possible d'acheter à part l'ampoule led disponible en deux versions:  
Für alle Artikel der Linie Luce besteht die Möglichkeit die LED Lampen in zwei Versionen zu erwerben:

**Luce led bianca optional**  
Additional led lamp  
Ampoule à leds supplémentaire  
Zusatz led Lampe



codice senza colore | Confezione minima  
code without colour | Minimum package  
**10 906 000** | 1 

**Luce led multicolor con telecomando optional**  
Multicoloured led lamp with remote control  
Ampoule à leds à couleurs changeantes avec télécommande  
Lampe led multicolor con telecomando optional



codice senza colore | Confezione minima  
code without colour | Minimum package  
**10 907 000** | 1 

Per installazione all'esterno. Certificati CE, classe di isolamento IP55, completi di cavo di alimentazione, presa bipolare, lampada. Non sono dotati di interruttore. Si consiglia che l'installazione all'esterno venga effettuata da personale qualificato. Le versioni outdoor sono dotate di un foro e un tubo per il drenaggio dell'acqua che si potrà accumulare nel contenitore. È fondamentale che il foro e il tubo non vengano ostruiti in modo tale da permettere un sicuro drenaggio. Per questo consigliamo di non mettere mai la pianta o la terra direttamente nel contenitore ma di posizionare sempre un sottovaso e un vaso di contenimento di dimensioni appropriate. Pulire frequentemente il foro e il tubo di drenaggio.

For outdoor installation. Certificates CE, IP55 dielectric strength class, complete with power cord, hole plug, lamp. Not equipped with a switch. It is recommended that the installation is made by qualified personnel. The outdoor version is equipped with a hole and a tube to drain water that might be accumulated in the container. It is important that the hole and the tube will not be obstructed so as to allow safe drainage. Therefore we recommend to never put the plant or the soil directly in the container but always place a saucer and a pot of appropriate sizes. Never put the soil or plant directly into the container. In this way you risk to obstruct the hole and the drainage tube compromising their operation and safety. Please clean frequently the hole and the drainage tube.

Ne jamais mettre la terre ou la plante directement dans le recipient. De cette manière il peut s'obstruer l'orifice et le tuyau de drainage en compromettant le fonctionnement et la sûreté. Mettre toujours un sous-vase ou un vase de la dimension appropriées à la plante. Nettoyer souvent le trou et le tube de drainage.  
Ne jamais mettre la terre ou la plante directement dans le recipient. De cette manière il peut s'obstruer l'orifice et le tuyau de drainage en compromettant le fonctionnement et la sûreté. Mettre toujours un sous-vase ou un vase de la dimension appropriées à la plante. Nettoyer souvent le trou et le tube de drainage.

Niemals Erde oder Pflanzen direkt in den Behälter setzen. Sie riskieren, dass Öffnung und Rohr der Drainage verstopfen und somit die Funktion und Sicherheit nicht gewährleistet ist. Benutzen Sie stets Pflanztopfuntersetzer oder Töpfe mit angepasster Größe für Behälter und Pflanze. Reinigen Sie regelmäßig Öffnung und Rohr der Drainage.  
Sie riskieren, dass Öffnung und Rohr der Drainage verstopfen und somit die Funktion und Sicherheit nicht gewährleistet ist. Reinigen Sie regelmäßig Öffnung und Rohr der Drainage.

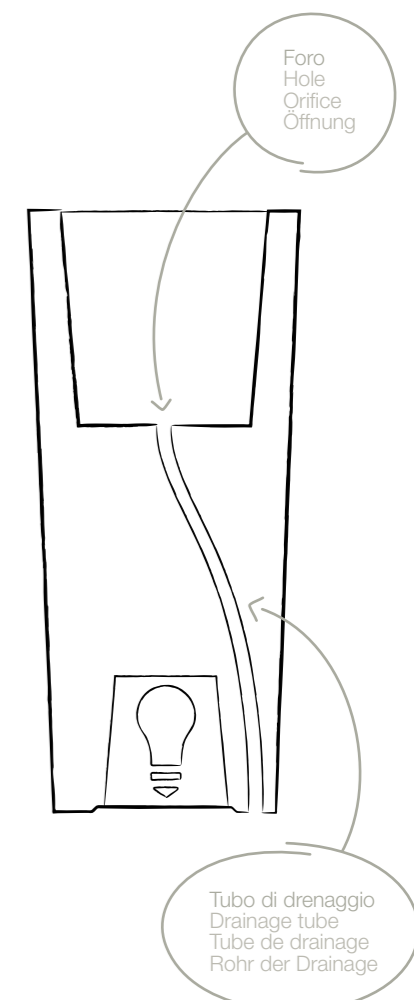

linea  
**GLOSSY**



tondo veneto



schio cono



valentino







# Tondo Veneto

Superficie lucida  
Glossy surface  
Surface brillante  
Glänzende Oberfläche

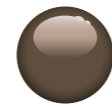

- 9003 Bianco Ral
- 193c Rosso Pantone
- 9005 Nero Ral

Tutti i colori RAL e Pantone disponibili a richiesta  
All RAL and Pantone colours available on request  
Toutes les couleurs RAL et Pantone sont disponibles sur demande  
All RAL und Pantone Farben sind auf Anforderung vorrätig

codice senza colore  
code without colour Cm

- 07 431 052 071 070 072 52
- 07 431 062 071 070 072 62

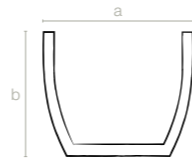

dimensioni dimensions	Confezione minima Minimum package	m <sup>3</sup>	pezzi pallet pcs pallet	m <sup>3</sup>
a52 b43	1 53x53x43h	0,10	15 80x120x227h	2,70
a62 b50	1 63x63x52h	0,20	10 80x120x207h	1,90

LINEAS  
GLOSSE



# Schio Cono

Superficie lucida  
Glossy surface  
Surface brillante  
Glänzende Oberfläche



- 9003 Bianco Ral
- 193c Rosso Pantone
- 9005 Nero Ral

Tutti i colori RAL e Pantone disponibili a richiesta  
All RAL and Pantone colours available on request  
Toutes les couleurs RAL et Pantone sont disponibles sur demande  
All RAL und Pantone Farben sind auf Anforderung vorrätig

codice senza colore  
code without colour Cm

- 07 424 090 071 070 072 90
- 07 424 110 071 070 072 110
- 07 424 145 071 070 072 145

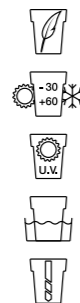
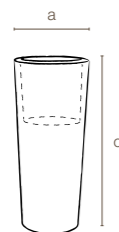

dimensioni dimensions	Confezione minima Minimum package	m <sup>3</sup>	pezzi pallet pcs pallet	m <sup>3</sup>
a40 b90	1 41x41x92h	0,10	12 80x120x195h	1,80
a45 b110	1 46x46x112h	0,20	12 80x120x236h	2,20
a55 b145	1 56x56x147h	0,40	4 100x120x160h	1,90



# Valentino

Superficie lucida  
Glossy surface  
Surface brillante  
Glänzende Oberfläche



- 9003 Bianco Ral
- 193c Rosso Pantone
- 9005 Nero Ral

Tutti i colori RAL e Pantone disponibili a richiesta  
All RAL and Pantone colours available on request  
Toutes les couleurs RAL et Pantone sont disponibles sur demande  
All RAL und Pantone Farben sind auf Anforderung vorrätig

codice senza colore  
code without colour Cm

- 07 432 070 071 070 072 70
- 07 432 090 071 070 072 90

dimensioni  
dimensions

Confezione minima Minimum package	m <sup>3</sup>	pezzi pallet pcs pallet	m <sup>3</sup>
1 43x43x72h	0,10	18 80x120x226h	2,10
1 53x53x92h	0,20	8 100x120x195h	2,30

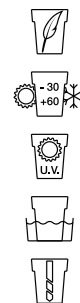
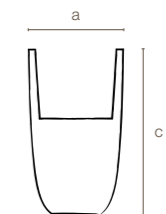

linea  
**BRILL**



tronco



cono





# Tronco

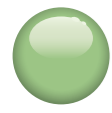

Superficie lucida  
Glossy surface  
Surface brillante  
Glänzende Oberfläche

# Cono



Superficie lucida  
Glossy surface  
Surface brillante  
Glänzende Oberfläche



**043**  
bianco/white  
blanc/weiß



**232**  
kiwi/kiwi  
kiwi/Kiwi



**208**  
menta/mint  
menthe/Minze



**231**  
fucsia/fuchsia  
fuchsia/fuchsienfarbig



**233**  
toffee/toffee  
caramel/Toffee



**037**  
nero/black  
noir/schwarz

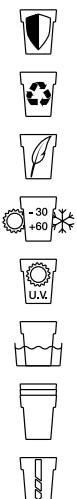

codice senza colore code without colour	Cm	dimensioni dimensions	Confezione minima Minimum package	m <sup>3</sup>	pezzi pallet pcs pallet	m <sup>3</sup>
<b>21 457 040</b>	40	a:39 b:35	1 40x40x37h	0,05	36 80x120x225h	2,16
<b>21 457 050</b>	50	a:49 b:41	1 50x50x43h	0,10	20 100x120x225h	2,70

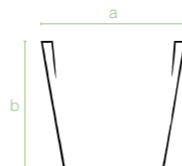

**043**  
bianco/white  
blanc/weiß



**232**  
kiwi/kiwi  
kiwi/Kiwi

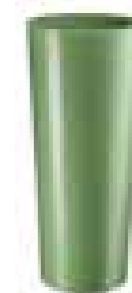

**208**  
menta/mint  
menthe/Minze



**231**  
fucsia/fuchsia  
fuchsia/fuchsienfarbig



**233**  
toffee/toffee  
caramel/Toffee



**037**  
nero/black  
noir/schwarz



codice senza colore code without colour	Cm	dimensioni dimensions	Confezione minima Minimum package	m <sup>3</sup>	pezzi pallet pcs pallet	m <sup>3</sup>
<b>21 453 060</b>	60	a:26 b:58	1 27x27x60h	0,04	36 80x120x195h	1,87
<b>21 453 070</b>	40	a:30 b:68	1 31x31x70h	0,06	24 80x120x225h	2,16
<b>21 453 080</b>	80	a:34 b:78	1 35x35x80h	0,09	12 80x120x175h	1,68

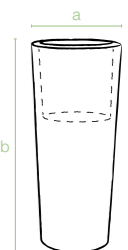



## Fix Ground round

ACCESSORI: articoli molto semplici ma di sicuro utilizzo. Fissati a una parete o sul pavimento riducono notevolmente le possibilità di ribaltamento accidentale.

ACCESSORIES: items very simple but certainly used. Attached to a wall or lying on the floor they reduced significantly the possibility of rollover accident.

ACCESSOIRES: des articles très simples mais sûrement utiles. Fixés au mur ou au plancher, ils réduisent considérablement le risque de renversement accidentel.

ZUBEHÖR: diese Artikel sind sehr einfach aber ganz sicherlich nützlich. Festgeschraubt auf einer Wand oder auf dem Boden, reduzieren sie stark das Umkippenrisiko.

codice senza colore code without colour	Cm	dimensioni dimensions	Confezione minima Minimum package	 m³
10 903 041	41	a41 b0,5	2 42x42x4h	0,01
10 903 048	48	a48 b0,5	2 50x50x4h	0,01
10 903 060	60	a60 b0,5	2 62x62x4h	0,01

## Fix Ground square

codice senza colore code without colour	Cm	dimensioni dimensions	Confezione minima Minimum package	 m³
10 908 039	39	a39 b0,5	2 40x40x4h	0,01



## Fix Wall

codice senza colore code without colour	Cm	dimensioni dimensions	Confezione minima Minimum package	 m³
10 904 007	7	a25 b0,5	2 25x15x5h	0,002

## Rotelle standard S3-3



codice senza colore code without colour	Confezione minima Minimum package	 m³
10 902 004	4x12 15x15x10h	0,002



# TeraPlast S.p.A.

Via del Progresso, 65 - GPS - Località Conca  
36070 Castelgomberto (VI) - ITALY  
tel. +39 0445 444 100 - fax +39 0445 444 111  
[www.teraplast.com](http://www.teraplast.com) - [info@teraplast.com](mailto:info@teraplast.com)

TeraPlast S.p.A. è un'azienda del gruppo

**MARGRAF**  
S.p.A. - INDUSTRIE PLASTICHE

